



2017
**OWNER'S
MANUAL**

**Kohler 1000 DIESEL
Kohler 750 EFI
Intimidator 800**



Owner Memo

Name: _____

Purchasing Date: _____

Type: _____

Pin Number: _____

Special Notice: _____

Key Number: _____

Table of Contents:

Title	Page Number
Introduction	Page 4
Definitions	Page 4
Safety Labels	Pages 4-8
ROPS Inspection Guide	Pages 9-10
General Safety	Pages 11-14
Safe Riding Gear	Page 15
Features, Controls and Operation	Pages 16-33
New Vehicle Break-in	Page 33
Service and Maintenance.....	Pages 34-71
Storing and Maintaining Appearance.....	Pages 72-73
Transporting your Intimidator.....	Page 74
Accessories	Page 74
Specifications	Pages 75-83
Troubleshooting	Pages 84-89
Warranties	Pages 90-99
Service Record	Pages 100-101
Training Certificate.....	Page 102
Safety Checklist.....	Page 103



INTRODUCTION

READ THIS OWNER'S MANUAL. The Intimidator is an off-road vehicle and is not a toy. The Intimidator is an adult vehicle only and can be hazardous to operate. Failure to follow the warnings and instructions in this manual can result in severe injury or death.

PIN NUMBER

Product Identification Number is located between the seat back and cargo bed.



DEFINITIONS

DANGER:

A Danger indicates a hazardous situation that, if not avoided, may result in serious injury or death.

WARNING:

A Warning indicates a situation that, if not avoided, may result in property damage.

Notice

A Notice indicates a situation that could result in property damage.

SAFETY LABELS

For your protection, warning labels have been placed on the vehicle. Read and follow the instructions of the labels on the vehicle carefully. If any label becomes illegible or comes off, contact your authorized dealer to purchase a replacement.

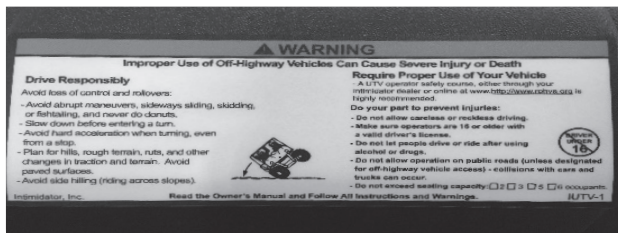

Discretionary and Age Warning – Located on vehicle dash.

DANGER:

Improper Use of Off-Highway Vehicles Can Cause Severe Injury or Death

Drive Responsibly

Avoid loss of control and rollovers:

- Avoid abrupt maneuvers, sideways sliding, skidding, or fishtailing, and never do donuts.
- Slow down before entering a turn.
- Avoid hard acceleration when turning, even from a stop.
- Plan for hills, rough terrain, ruts, and other changes in traction and terrain. Avoid paved surfaces.
- Avoid side hilling (riding across slopes).

Require Proper Use of Your Vehicle

Do your part to prevent injuries:

- Do not allow careless or reckless driving.
- Make sure operators are 16 or older with a valid driver's license.
- Do not let people drive or ride after using alcohol or drugs.
- Do not allow operation on public roads (unless designated for off-highway vehicle access) – collisions with cars and trucks can occur.
- Do not exceed seating load capacity.

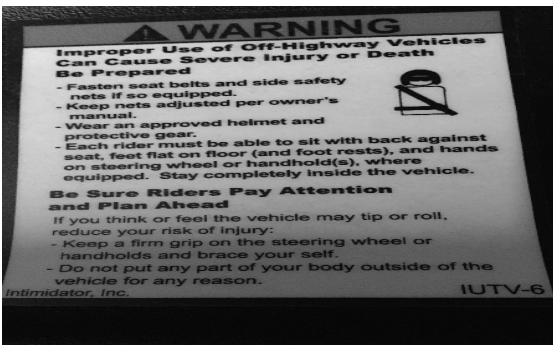

Seatbelt and Safety Warning – Located on vehicle firewall.

DANGER:

Operator and passengers must fasten seatbelt and both safety cab nets while the vehicle is in use. Safety cab net must remain tight at all times and not be damaged. If safety cab net is damaged or shows significant wear, do not use vehicle until a new safety net is installed.



Improper Use of Off-Highway Vehicles Can Cause Severe Injury or Death.

Be Prepared:

- Fasten seatbelts.
- Wear an approved helmet and protective gear.
- Fasten side safety nets.
- Each rider must be able to sit with back against seat, feet flat on floor (and foot rests), and have hands on steering wheel or handhold(s), where equipped. Stay completely inside the vehicle.

Be Sure Riders Pay Attention and Plan Ahead

If you think or feel the vehicle may tip or roll, reduce your risk of injury:

- Keep a firm grip on the steering wheel or handholds and brace yourself.
- Do not put any part of your body outside of the vehicle for any reason.



- **ROHVA and ISO Certification Sticker** – Located on the driver's side below the roll cage.

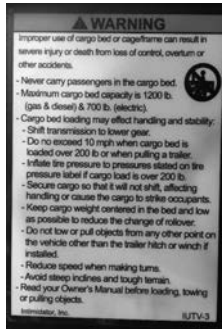

Cargo Bed Safety Warning – Located in the cargo bed. Improper use of cargo bed or cage/frame can result in severe injury or death from loss of control, overturn or other accidents.

- Never carry passengers in the cargo bed.
- Classic and Truck-Series maximum cargo bed capacity is 1200 lbs.
- Crew-Series maximum cargo bed capacity is 1000 lbs.
- Do not exceed 10mph when cargo bed is loaded over 200 lbs.
- Inflate tire pressure to pressures stated on tire pressure label (Page 8).
- Secure cargo so that it will not shift, which will affect handling or cause the cargo to strike occupants.
- Keep cargo weight centered in the bed and low as possible to reduce the chance of rollover.
- Do not tow or pull objects from any other point on the vehicle other than the trailer hitch or winch if installed.
- Reduce speed when making turns.
- Avoid steep inclines and rough terrain.
- Read your Owner's Manual before loading, towing or pulling objects.



Tilt Cargo Bed Warning – Located near the handle on the driver's side of the cargo bed.

WARNING

Keep hands, body, and other people away from pinch points when lowering bed.
Do not hold the cage/frame while closing bed.



Tire Pressure Chart

TIRE PRESSURE AND SIZE CHART

Vehicle Position	Size	Load Rating (lb)	Air Pressure (psi)	Top Speed Rating (mph) @ Max Load	Max Payload
Front	27x10R14	750	18	10	Loaded
Rear	27x12R14	1275	22	10	
Front	27x10R14	680	12	35	Unloaded
Rear	27x12R14	1000	12	35	

Rollover Protective Structures (ROPS) Inspection Guide

ROPS, like any other safety device, need to be periodically inspected to verify that the integrity of the device has not been compromised through normal machine use, misuse, age degradation, modifications, or roll-overs.

Some mechanical discretion is essential, therefore personnel who inspect ROPS need to comprehend and understand the significance of issues like structural corrosion, cracks, and deformation. Conservatism is the essential rule – if in doubt, remove the machine from service and contact the ROPS manufacturer for assistance. Certain conditions will absolutely render the ROPS unusable, examples are:

- Permanent deformation or twisting.
- Missing, damaged, or loose mounting hardware.
- Mounting hardware that is of a grade lesser than specified.
- Any cracks in the structure (structural members and/or welds).
- Significant corrosion.
- Modifications, i.e. unauthorized welds and holes.
- Missing or unreadable ROPS label.
- Applicable ROPS machine model not specified on the ROPS label.
- Missing seatbelts.
- Incomplete/improper installation.

Other conditions may require imminent service but may not render the unit immediately unusable, examples are:

- Faded paint.
- Faded, hard to read ROPS label.
- Slightly corroded mounting hardware.



ROPS must be inspected immediately after any type of collision, rollover or impact. If any damage is evident, the ROPS must be removed from service, repaired and/or replaced.

When a ROPS is removed or reinstalled, mounting hardware must be examined for signs of over stressing. Damaged mounting hardware must be replaced with proper specification hardware before placing the ROPS back in service.

Properly maintained seatbelts are essential to compliment the operator crush protection designed into the ROPS. All seatbelt and/or seatbelt anchorage systems that show evidence of cuts, fraying or wear, significant discolorations due to exposure to the elements, heavily soiled especially with oil, grease, or fuel, or any type of damage must be immediately replaced, regardless of age.

Operators are to be instructed to properly adjust and use seatbelts at all times.

GENERAL SAFETY

NEVER OPERATE

- If you are under age 16 or without a valid driver's license.
- At speeds too fast for your skills or conditions.
- After or while using Alcohol or Drugs.
- On hills steeper than 15 degrees.
- On public roads or paved surfaces.
- With more than two passengers (five for crew models), or passengers who are under age 12, or may be too young to reach grab handles.
- With passengers in cargo box.
- With non-approved accessories or modifications—they may seriously affect stability.

ALWAYS

- Wear your seatbelt. Vehicle rollover could cause death or serious injury.
- Make sure all latches are secure and safety cab net is tight before operating the vehicle.
- Wear a helmet and eye protection.
- Reduce speed and use extra caution while carrying passengers.
- Avoid sharp turns or turns while applying heavy throttle.
- Operate slowly in reverse – avoid sharp turns or sudden braking.
- Make sure passengers read and understand all safety labels.

OPERATOR SAFETY

- Operator and passengers must fasten seatbelts and both safety cab nets while the vehicle is in use. Safety cab net must remain tight at all times and not be damaged. If safety cab net is damaged or shows significant wear, do not use vehicle until a new safety net is installed.
- Never operate your vehicle in fast-flowing water or in water deeper than the floorboard. It may void the warranty. Wet brakes may have reduced stopping ability. Test your brakes after leaving water. If necessary, apply them lightly several times to let friction dry out the pads.
- Check terrain before attempting to climb a hill. Never



climb hills with excessively slippery or loose surfaces. Never open the throttle suddenly or make sudden gear changes. Never go over the top of a hill at high speeds.

- Always use the proper size and type of tires specified in this manual. Always maintain proper tire pressure as specified on safety labels.
- Never modify this vehicle through improper installation or use of accessories.
- Never exceed the stated load capacity for this vehicle. Cargo should be properly distributed and securely attached. Reduce speed and follow the instructions in this manual for hauling cargo or pulling a trailer. Allow greater distance for braking.
- Always put the vehicle in Park before getting out of the vehicle.
- Always stop the engine before refueling. Remove flammable material containers from the cargo box before filling them with fuel. Make sure the refueling area is well ventilated and free of any source of flames or sparks. Gasoline is very flammable.
- Always remove the ignition key when the vehicle is not in use to prevent unauthorized use or accidental starting.
- Exhaust system components are very hot during and after use of the vehicle. Hot components can cause burns and fire. Do not touch hot exhaust system components. Always keep combustible materials away from the exhaust system. Use caution when traveling through tall grass, especially dry grass. Never start the engine or let it run in an enclosed area.
- Do not carry a passenger until you have at least two hours of driving experience with the Intimidator.
- Always keep hands and feet inside the vehicle at all times.
- Always inspect the vehicle before each use to make sure it's in safe operating condition. Follow inspection procedures described in this manual.

Operating a Damaged Vehicle

Operating a damaged vehicle can result in an accident. In case of an overturn or other accident, have a qualified service dealer inspect the entire machine for possible damage, including (but not limited to) brakes, throttle and steering systems.

Operating at Excessive Speeds

Operating this vehicle at excessive speeds increases the operator's risk of losing control.

Operating on Pavement

This vehicle's tires are designed for off-road use only, not for use on pavement. Operating this vehicle on paved surfaces may cause quick tire wear and may adversely affect the handling of the vehicle and could result in loss of control, accident or overturn. Avoid operating the vehicle on pavement. If it's unavoidable, travel slowly and avoid sudden turns or stops.

Turning Improperly

Turning improperly could cause loss of traction, loss of control, accident or overturn. Always follow turning procedures for turning. Never turn abruptly or at sharp angles. Never turn at high speeds. Never abruptly accelerate while turning.

Jumps and Stunts

Attempting wheelies, jumps and other stunts increase the risk of an accident or overturn. Never attempt wheelies, jumps or other stunts. Avoid exhibition driving.

Improper Hill Climbing

Climbing hills improperly can cause loss of control or vehicle overturn. Do not climb a hill or drive down a hill over 15 degrees.

Stalling While Climbing a Hill

Stalling or rolling backward while climbing a hill could cause an overturn. Always maintain a steady speed when climbing a hill.

If all forward speed is lost:

- Apply the brakes. Place the transmission in reverse and slowly allow the vehicle to roll straight downhill while applying light brake pressure to control speed.



If you begin rolling downhill backward:

- Never apply engine power. Apply the brakes gradually until the vehicle is fully stopped. Place the transmission in reverse and slowly allow the vehicle to roll straight downhill while applying light break pressure to control speed.

Improper Tire Maintenance, Type or Size

Operating this vehicle with improper tire size or type may void the warranty. See your dealer for details. Operating this vehicle with uneven or low tire pressure could cause loss of control or accident. Always use the size and type of tires specified for your vehicle. Always maintain proper tire pressure as described in the owner's manual and on the safety labels.

Equipment Modifications

We strongly recommend that consumers do not install any after-market equipment that may increase the speed or power of the vehicle, or make any other modifications to the vehicle for these purposes. Any modifications to the original equipment of the vehicle create a substantial safety hazard and increase the risk of bodily injury.

The warranty of the Intimidator will be terminated if any unauthorized equipment has been added to the vehicle, or if any modifications have been made to the vehicle, that increase the speed or power.

The addition of certain accessories, including (but not limited to) mowers, blades, large tires, sprayers, or large racks, may change the handling characteristics of the vehicle. Use only factory approved accessories, and familiarize yourself with their function and effects on the vehicle.

SAFE RIDING GEAR

Always wear appropriate clothing when riding the Intimidator. Wear protective clothing for comfort and to reduce the chance of injury.

Helmet

Wearing a helmet can prevent a severe head injury. Whenever riding the Intimidator or any Utility Vehicle, always wear a helmet that meets or exceeds established DOT (U.S. Department of Transportation) safety standards.

Eye Protection

Do not depend on eyeglasses or sunglasses for eye protection. Always wear shatterproof goggles or use a shatterproof helmet face shield.

Gloves

Wear gloves for comfort and for protection from sun, cold weather and other elements.

Boots

Wear sturdy footwear. Do not drive or ride vehicle with bare feet.

Clothing

Wear long sleeves and long pants to protect arms and legs.



FEATURES, CONTROLS and OPERATION

Ignition Key

Your key is a series type key, of which there are a high range of numbers. It is highly recommended that you obtain additional copies of your key. If all keys are lost, a replacement ignition switch must be installed.

Starting the Kohler 1000 Diesel

Diesel vehicles have glow plugs that have to warm up. To start the diesel engine, press the brake pedal and turn the ignition on and wait three seconds before cranking the engine.

Starting the Kohler 750 EFI

To start the engine, press the brake pedal and turn the ignition on. For the best throttle response and performance, allow the gas engine to idle for one minute after each cold start before giving the vehicle acceleration.

Starting the Intimidator 800 EFI

To start the engine, press the brake pedal and turn the ignition on.

Instrument Cluster



Your Intimidator is equipped with a digital LCD screen. High pressure water or soap may damage components. The LCD screen will display the following:

- Seatbelt Reminder
- Kohler 750 Gas and 1000 Diesel Gear Indicator
 - Displays the gear shifter position.

- P – Park**
- R – Reverse**
- N – Neutral**
- L – Low Gear**
- H – High Gear**

- Intimidator 800 Gear Indicator – Displays the gear shifter position.

- P – Park**
- R – Reverse**
- N – Neutral**
- L – High Gear**
- H – Low Gear**

- Battery Voltage Meter – Measures the amount of power in the battery. Normal operating range is between 12.8 and 14 volts.
- Engine Temperature (Kohler 1000 Diesel and Intimidator 800).
- Fuel Gauge – Shows the level of fuel in the fuel tank. When the tank is full, all bars will be shown black.
- RPM – Engine Revolutions Per Minute.
- Odometer – Displays the overall distance traveled by the vehicle.
- Engine Hours – Displays the overall hours the engine has operated.
- Menu – Adjust LCD screen brightness.

To adjust the LCD backlight brightness:



- Press the center button once
- Press either the 1st, or 2nd, button from the left to adjust brightness up or down

Switches



- A - Light Switch
- B - 2wd/4wd Switch
- C - Locking Rear Differential
- D - Electric Dump Bed (If equipped)

Lights

All models come equipped with the new automotive style headlight. Press the left side of the rocker switch to turn on the low beam lights. Press the right side of the rocker switch to turn on high beam lights. The middle position of the switch is off.

Dash Lights

All of your warnings and lights can be found either on the main screen of the display gauge or under the diagnostics screen. Under diagnostics you will find all error codes that you've received.

Engaging and Disengaging 4WD

WARNING:

- Do not drive in 4wd on a paved surface.
- Do not engage 4wd while the rear wheels are spinning without traction. This may cause severe drive-shaft and clutch damage. Always engage 4wd while the rear wheels have traction or are at rest.
- Engage 4wd before getting into conditions where front wheel drive may be needed. If the rear wheels are spinning, release the throttle before switching to 4wd.

To engage 4wd, press the 4wd dash switch so that the switch light is illuminated. You may engage 4wd while the vehicle is moving while taking the precautions mentioned above.

To disengage 4wd, press the 4wd dash switch so that the switch light is off. In some situations, the front differential may remain locked after turning the 4wd switch off. If this occurs, you may continue to notice increased steering effort and some vehicle speed restrictions. Perform the following procedure to unlock the front differential.

1. Stop the vehicle.
2. Operate in reverse for at least 10 feet.
3. Shift into a forward gear and drive.

Locking Rear Differential

The rear differential lock switch is located on the driver's side of the dash to the immediate right of the steering wheel. To engage the differential lock, press the left side of the switch and the switch light will turn on, meaning the differential lock is engaged. If one of the rear wheels should slip, press the switch to turn on the differential lock. Both wheels will then turn together, reducing slippage.

When the ignition is turned off, the rear differential locker is automatically engaged.

DANGER:

- Steering and vehicle performance will be altered with the rear differential lock engaged.
- Do not operate faster than 10 mph.
- Do not attempt to turn with the differential lock engaged.

Electric Dump Bed (if equipped)

Press and hold the left side of the rocker switch to dump the cargo bed. Quickly release the switch when the tilt height has maxed out or the actuator starts to make a clicking sound. To lower the bed, press and hold the right side of the rocker switch. Quickly release the switch when the bed is down or the actuator starts to make the same clicking sound.

ELECTRICAL

Accessory, 12V Electrical Outlet

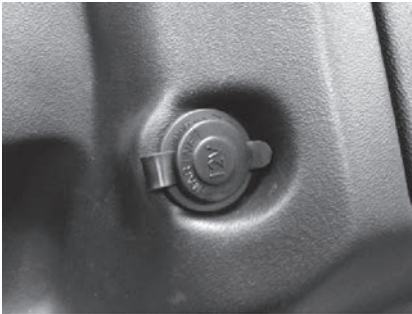

The 12 volt receptacle is located on the passenger side of the dash, left of the glove box.

- This outlet is activated when the key is switched to the "ON" position.
- Do not connect any device that draws more than 120 watts to this connector or the battery may discharge very rapidly or the outlet may fail.
- Do not use as a cigarette lighter.
- Do not use when wet.
- Unplug accessory when the vehicle key is switched to the "OFF" position.

Adding Switches and In-dash Accessories

Your Intimidator is designed to allow the dealer to add more switches for accessories and “built-in” accessories like a GPS or radio in the center of the dash above the cup holders. The dash has to be modified to fit most accessories. To minimize the risk of damage to the vehicle, contact your authorized dealer.

Parking Brake

WARNING: The vehicles gear shift lever comes properly adjusted from the factory so that the Park gear is fully engaged and will not slip out of Park. During every pre-ride inspection, inspect that the gear shift lever is fully engaged into Park and will not slip out of Park. Have your authorized dealer annually inspect, lubricate, adjust or replace the shifter cable.

Your Intimidator is equipped with a Park gear in the gearbox. While your vehicle is in Park with the ignition off, both rear wheels will lock. Your vehicle’s transmission should be engaged in “P” (Park) at all times when not in use. It is okay to engage and disengage your vehicle in “P” (Park) on an incline. If you are hauling or towing heavy loads, always Park on level ground.

WARNING:

When your vehicle is not in use or key is switched to the off position, always place the transmission in “P” (Park).

Always tie down your vehicle with chains or straps when being transported on a truck or trailer. Never rely only on the Parking Brake. See “Transporting your Intimidator” on page 65.

To Engage the Parking Brake

Use the shifter on the right side of steering wheel to place the vehicle’s gearbox into Park.



Rollover Protection Structure (ROPS)

The Rollover Protection Structure (ROPS) on this vehicle meets American National Standard Institute (ANSI) Standards and OSHA standards for rollover performance requirements. Always have authorize Intimidator, Inc., dealer thoroughly inspect the ROPS if it ever becomes damaged in any way.

No device can assure occupant protection in the event of a rollover. Always follow safe operating practices outlined in this manual to avoid a vehicle rollover.

DANGER:

- Vehicle rollover could cause serious injury or death. Always avoid operating in a manner that could result in vehicle rollover.
- Do not grab or hold ROPS while vehicle is moving. If a rollover occurs, holding to the roll cage could crush your hand.
- Modifying or cutting the ROPS can cause serious injury or death.
- Do not add any unauthorized accessory that bolts into the ROPS mounting points.

Seat Removal

Pull up on the front of the seat and slide it towards the front of the vehicle. To install the seat, slide the seat into the rear of the seat base until the two metal stud attached to the front of the seat are aligned with the two rubber grommets attached to the front of the seat base. Push down firmly on the front of the seat until the studs are fully seated into the grommets.

Seatbelts & Safety Cab Nets



DANGER: Falling from a moving vehicle could result in serious injury or death. Always fasten your seatbelt and secure the safety cab net.

DANGER: Riding in this vehicle without using the factory installed cab nets increases the risk of serious injury or death in the event of an accident or overturn. They must be used by both operator and passengers at all times. Make sure all latches are secure before operating the vehicle. Always inspect cab nets for tightness, wear and damage before each use.

This vehicle is equipped with 3-point seatbelts for occupants. Always make sure the seatbelts are secured for all riders before operating.



Tilt Steering

Your Intimidator is equipped with tilt steering that can be adjusted by pulling the tilt-steering lever towards you, then lifting the steering wheel up or down. The tilt-steering lever is located on the steering column, just behind the steering wheel.



Shifting Gears

The Intimidator is equipped with a gear selection icon, shown on the instrument clusters digital display. The brake pedal must be applied in order to start the vehicle and should be applied while shifting. You must come to a complete stop before shifting.

WARNING: The vehicle's gear shifter comes properly adjusted from the factory so that the Park gear is fully engaged and does not slip out of Park. Have your authorized dealer annually inspect, lubricate, adjust or replace the shifter cable.

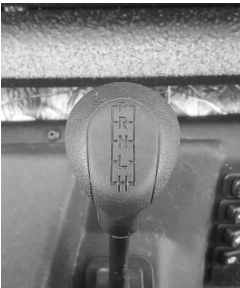

Hauling Cargo

DANGER:

Always follow these precaution when hauling cargo:

- Always refer to Cargo Bed Safety Warning located in the cargo bed.
- Driving with passengers in the cargo box can result in severe injury or death. Never allow passengers to ride in the cargo box. Passengers must always ride in the cab with seatbelts fastened securely.
- Hauling cargo improperly can alter vehicle handling and may cause loss of control or brake instability, which can result in serious injury or death.
- Never exceed the maximum weight capacity of the vehicle. When determining the weight you are adding to the vehicle, include the weight of the operator, passenger, accessories, cargo loads and the load on the trailer tongue. The combined weight of these items must not exceed the maximum weight capacity.
- Reduce speed and allow greater distances for braking when hauling cargo.
- Always load the cargo box with the load as far forward and as low as possible.
- When operating over rough or hilly terrain, reduce speed and cargo to maintain stable driving conditions.
- Always operate the vehicle with extreme care when hauling or towing loads.
- Slow down and drive in low range if possible.
- Secure all loads before operating.
- Vehicle should never exceed 10 mph (16 kph) while towing a heavy load on a level grass surface. Vehicle speed should never exceed 5 mph (8 kph) when towing heavy loads in rough terrain, while cornering, or while

- ascending or descending a hill.
- **HEAVY LOADS CAN CAUSE BRAKING AND CONTROL PROBLEMS.** Use extreme caution when applying brakes with a loaded vehicle. Avoid terrain or situations that may require braking downhill. Allow yourself extra distance for braking.

Dumping the Cargo Box

WARNING:

If the cargo box is loaded to full weight capacity, it may be difficult to dump. Use extreme caution.

To use the cargo dump box:

1. Select a level site to dump the cargo box. Do not attempt to dump or unload the vehicle while parked on an incline.
2. Apply the brakes. Place the gearbox in Park.
3. Dismount the vehicle.
4. Ensure that the cargo is positioned evenly.

DANGER: If the weight distribution on the box is located towards the rear of the box when the release lever is lifted, the box may dump unexpectedly and cause serious injury.

5. Stand clear and pull up on the cargo box release lever, located on the diver's-side cargo box control handle. Lift the front of the cargo box to dump the cargo.
6. Lower the cargo box and push down securely to latch.



Bed handle and lever to release bed latch

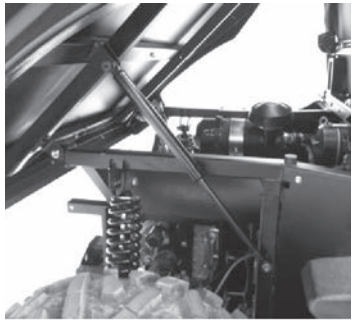

Standard lift assist on dump box

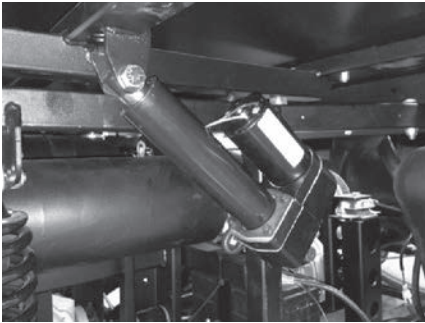

Electric actuator on dump box

Cargo Bed Tailgate

To open the tailgate, twist the latch on the middle of the tailgate, then pull. The tailgate is supported by a lever on each side of the cargo bed. Do not remove the levers.

DANGER:

To avoid personal injury, do not sit or stand on the tailgate. Do not place fingers or hands between the tailgate and the arm (latch) when closing, or fingers or hands may be pinched.

Towing Loads

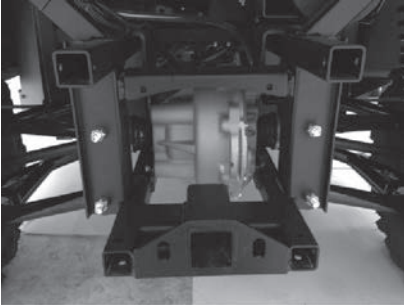

2" rear receiver hitch

Towing improperly can alter vehicle handling and may cause loss of control or brake instability.

Always follow these precautions when towing:

1. Never load more than 300 lbs. tongue weight on the rear towing bracket.
2. Never load more than 200 lbs. tongue weight on the front towing bracket.
3. Do not operate the vehicle faster than 10 MPH when hauling or towing loads on a level surface.
4. Vehicle speed should never exceed 5 MPH when hauling or towing loads on uneven surfaces, rough terrain, cornering, or while ascending or descending a hill.
5. Do not tow more than the recommended weight for the vehicle.
6. Attach a trailer to the rear trailer hitch bracket only. Do not attach a trailer to any other location or you may lose control of the vehicle.
7. Never tow a trailer on a grade steeper than 15 degrees.
8. **Always operate in low range when hauling or towing in excess of 200 lbs.**

Intimidator Tow Capacity Chart

Model	Max. Towed Load Weight on level ground*	Max. Towed Load Weight on 15 degree grade*	Max. Rear Hitch Tongue Weight	Max. Front Hitch Tongue Weight	Maximum Towing Speed on level ground*	Maximum Towing Speed on 15 degree grade*
Classic-Series 750 EFI	2,100 lbs.	1,000 lbs.	300 lbs.	200 lbs.	10 mph (16 kph)	5 mph (8 kph)
Crew-Series 750 EFI	2,100 lbs.	1,000 lbs.	300 lbs.	200 lbs.	10 mph (16 kph)	5 mph (8 kph)
Truck-Series 750 EFI	2,100 lbs.	1,000 lbs.	300 lbs.	200 lbs.	10 mph (16 kph)	5 mph (8 kph)
Classic-Series 800 EFI	2,100 lbs.	1,000 lbs.	300 lbs.	200 lbs.	10 mph (16 kph)	5 mph (8 kph)
Crew-Series 800 EFI	2,100 lbs.	1,000 lbs.	300 lbs.	200 lbs.	10 mph (16 kph)	5 mph (8 kph)
Classic-Series 1000 Diesel	2,100 lbs.	1,250 lbs.	300 lbs.	200 lbs.	10 mph (16 kph)	5 mph (8 kph)
Crew-Series 1000 Diesel	2,100 lbs.	1,250 lbs.	300 lbs.	200 lbs.	10 mph (16 kph)	5 mph (8 kph)
Truck-Series 1000 Diesel	2,100 lbs.	1,250 lbs.	300 lbs.	200 lbs.	10 mph (16 kph)	5 mph (8 kph)

*In low range

Adjusting Rear Spring Position



All four shock absorbers have four (4) spring position adjustments on the top, which will tighten or loosen the spring travel rate to adjust the suspension for different terrain and payload conditions. If you plan to haul heavy cargo or have a heavy accessory, like a snowplow, you can tighten the spring rate by moving the silver ring up. In doing so, the vehicle will not squat as much, giving you more ground clearance and better steering control.

In addition to the four spring position adjustments, the rear shock absorbers have multiple mounting positions to further adjust the stiffness of the ride by changing the angle in which the shocks are mounted. With heavy loads, the shocks should be mounted in a near-vertical position. If you haul light-to-medium size loads and want a smoother ride, the shocks can be mounted in more of an angle, which also will increase wheel travel.

DANGER:

To avoid personal injury, be sure to work on a firm, flat and level surface with the engine shut off, transmission in "P" (Park). Keep the position of the left and right shock absorbers equal. Uneven adjustments can cause poor handling and loss of control, which could lead to an accident.

NOTICE: You will need a special tool to adjust the shock spring rate or take your vehicle to an authorized dealer.

Fuel

DANGER:

Handle fuel carefully. If the engine is running, do not fill the fuel tank. Do not smoke while filling the fuel tank or servicing the fuel system. Fill fuel tank only to bottom of filler neck.

Kohler 750 EFI and Intimidator 800 Engine

NOTICE:

Effects of old, stale or contaminated fuel are not warrant-able. It is recommended to use only unleaded gasoline with an index rating of 90 or higher.

The higher the rating, the better the engine will run.

- Use fuel within approximately 30 days after purchase to avoid deterioration in gasoline quality, or add fuel stabilizer to keep fuel fresh and stabilized.
- Gasoline blend differs from season to season for the best seasonal engine performance. To prevent engine performance troubles such as vapor lock or hard starting, use gasoline within the season in which the fuel is purchased.
- Never remove the fuel tank cap or add fuel with the engine running. Allow the engine to cool before refueling.
- Never overfill fuel tank. Replace the fuel tank cap and tighten securely.
- Clean up spilled fuel immediately. If fuel is spilled near vehicle, do not attempt to start the engine but move the vehicle away from the area of spillage.

Kohler 750 and Intimidator 800 fuel must meet these requirements:

- Clean, fresh, unleaded gasoline.
- Octane rating of a minimum of 87



(R+M)/2 or higher. Octane of 91 highly recommended. DO NOT use E15, E20 and E85 fuels.

- Research Octane Number (RON) 90 octane minimum.
- Gasoline up to 10% alcohol, 90% unleaded is acceptable.
- Methyl Tertiary Butyl Ether (MTBE) and unleaded gasoline blend (max 15% MTBE by volume) are approved.
- Do not add oil to gasoline.

Kohler 1000 Diesel

DANGER:

Handle fuel carefully. If the engine is running, do not fill the fuel tank. Do not smoke while filling the fuel tank or servicing the fuel system. Fill fuel tank only to bottom of filler neck. Leave room for the fuel to expand. Immediately clean up spillage during refueling.

NOTICE:

High sulfur content in fuel may cause engine wear.

Kohler 1000 Diesel Fuel Type

For best results, use only clean, fresh, commercial-grade diesel fuel. Diesel fuels that satisfy the following specifications are suitable for use in this engine: ASTM D-975 – 1D or 2D, EN590, or equivalent.

Fuels for Low Temperatures

It is possible to run the engine at temperatures below 0 degrees Celsius using special winter fuels.

Biodiesel Fuel

Fuels containing less than 20% methyl ester or B20 are suitable for use in this engine. Biodiesel fuels meeting the specifications of BQ-9000, EN 14214 or equivalent are recommended. DO NOT use vegetable oil as a biodiesel for this engine. Any failures resulting from the use of fuels other than recommended will not be warranted.

Bleeding the Kohler 1000 Diesel Fuel System

1. Loosen the union bolt connected to the pipe coming from the injection pump overflow.
2. Turn the ignition key to first position to power the solenoid valve.
3. Operate fuel pump with lever on mechanical feeding pump.
4. NEVER manually operate the fuel pump with the engine turning over or running.
5. After air has been purged from the system, tighten the union bolt.

NEW VEHICLE BREAK-IN

The break-in period for your new Intimidator UTV equipped with our 800CC engine is the first 5 hours or 100 miles. No single action on your part is more important than ensuring your vehicle has a proper “break-in”. Careful treatment of any new engine will result in more efficient performance and longer life for the engine.

Do not go over half throttle for the first 5 hours or 100 miles on models equipped with the Intimidator 800 engine. This would be considered to be 3500-4000 rpms.

On models with the Kohler 750 gas engine and Kohler 1000 Diesel, you may go over half throttle but avoid prolonged high-rpms for the first 5 hours or 100 miles. Your engine, differentials and gearbox need time to break in to ensure all gaskets and essential parts “seal” correctly. This will prevent any unnecessary leaks or compression leaks.

Once you have reached 5 hours in the Intimidator 800 and 25 hours in the Kohler 750 and Kohler 1000 diesel you will need to go in for your first service.

The first service is essential for double checking anything that could be a potential problem in the future. You own an off-road vehicle, the UTV vibrates while riding and can cause bolts to come loose, issues to come up, etc. We suggest your dealer perform the service work.

NOTICE: The first 5 hours of operation are the most sensitive. Do not operate at full throttle or high speeds for extended periods during this time.



SERVICE AND MAINTENANCE

Periodic Maintenance Chart

(following pages 36-37)

Careful periodic maintenance will keep your vehicle in the safest, most reliable condition. Inspection, adjustment and lubrication of important components are explained in the periodic maintenance chart.

Inspect, clean, lubricate, adjust and replace parts as necessary. When inspection reveals the need for replacement parts, use genuine Intimidator, Inc. parts available from your certified Intimidator dealer.

Maintenance intervals in the following chart (pages 36-37), are based upon average riding conditions and an average vehicle speed of approximately 10 miles per hour. Vehicles subject to severe use must be inspected and serviced more frequently.

Severe Use Definition

- Extended idle.
- Short-trip cold weather operation.
- Prolonged low-speed, heavy-load operation.
- Frequent or prolonged operation in dusty environments.
- Frequent immersion in mud, water or sand.
- Prolonged high speed and high RPM use.

If your vehicle falls under the Severe Use definition, perform all maintenance at intervals more frequent than stated on the chart.

Kohler 750 EFI Engine Specifications

Bore	83 mm (3.27 in.)
Stroke	69 mm (2.72 in.)
Displacement.....	747 cc (45.6 cu. in.)
Oil Capacity (refill)*	1.9 L (2.0 quarts)
Oil Type.....	Intimidator SYN 5W-40**
Spark Plug Gap.....	0.76 mm (0.3 in.)
Maximum Angle of Operation (@ full oil level).....	25 degrees

* Filter capacity not included. Always check the dipstick before operation.

** Factory-filled with and recommend using this fluid

Intimidator 800 EFI Engine Specifications

Displacement.....	800 cc (48.8 cu. in.)
Oil Capacity (refill)*	1.9 L (2.0 quarts)
Oil Type.....	Intimidator SYN 5W-40**
Valve Clearance (Intake).....	.05 mm to .09 mm
Valve Clearance (Exhaust).....	.1mm to .15 mm
Recommended Spark Plug	NGK – DCPR8E
Spark Plug Gap.....	0.7–0.9 mm (0.028 - .035 in.)
Maximum Angle of Operation (@ full oil level).....	25 degrees

* Filter capacity not included. Always check the dipstick before operation.

** Factory-filled with and recommend using this fluid

Kohler 1000 Diesel Engine Specifications

Cylinders.....	3
Bore	75 mm (2.95 in.)
Stroke	77.6 mm (3.1 in.)
Displacement.....	1028 cc (62.7 cu. in.)
Oil Capacity (refill)*	2.5 Quarts
Oil Type.....	Intimidator SYN 5W-40**
Maximum Angle of Operation (Continuous @ full oil level).....	25 degrees

* Filter capacity not included. Always check the dipstick before operation.

** Factory-filled with and recommend using this fluid



PERIODIC MAINTENANCE

800 Gas	750 Gas	1000 Diesel	EV	ITEM
X	X	X	X	Clean engine surroundings and components from debris
X	X	X	X	Cab safety nets
X	X	X	X	Seatbelts
X	X	X	X	Shift linkage
X		X		Coolant hoses
X		X		Coolant level
X	X	X	X	Brake fluid level
X	X	X	X	Brake system/Throttle pedal travel
X	X	X		Fuel and oil level
X	X	X	X	Steering
X	X	X	X	Front suspension
X	X	X	X	Rear suspension
X	X	X	X	Tires
X	X	X	X	Wheels/fasteners
X	X	X	X	Frame and fasteners
X	X	X	X	Headlamp & taillights
X	X	X	X	Axle and steering joint boots
X				Change engine oil (initial break-in only)
X	X	X		Check Air filter
X				Check 800 valve clearance
X	X	X	X	Brake pad wear
X	X	X		Service or replace air filter
	X	X		Change engine oil and filter (initial break-in only)
X				Change engine oil and filter(2 nd change only)
X	X	X	X	Battery
X	X	X	X	Transmission/gearbox oil
X	X	X	X	Rear differential oil
X	X	X	X	Front differential oil
X				Change engine oil and filter (reoccurring change)
	X	X		Change engine oil (reoccurring change)
	X			Check engine oil cooler fins
X	X	X	X	Lubricate driveshaft u-joints
X	X	X	X	Shift linkage
X	X	X	X	Steering
X	X	X	X	Throttle cable
X	X	X		CVT belt
X				Check 800 valve clearance
X	X	X		Fuel system
X		X		Replace engine coolant
X	X	X	X	Engine mounts
X	X	X	X	Wiring
X	X			Spark plugs
X	X			Ignition timing
X	X	X		Exhaust system
X	X	X	X	Brake fluid
X	X	X		CVT Clutch
X	X	X	X	Wheel bearings
X	X	X	X	Toe adjustment

MAINTENANCE INTERVAL (whichever comes first)		REMARKS
Hours	Calendar	
	Pre-Ride	Clean. Do not pressure wash
	Pre-Ride	Check for tightness, damage and operation
	Pre-Ride	Check for damage and operation
	Pre-Ride	Make sure Park will fully engage. Adjust if necessary
	Pre-Ride	Inspect. Make adjustments or replace as needed
	Pre-Ride	
	Pre-Ride	
	Pre-Ride	
	Pre-Ride	
	Pre-Ride	
	Pre-Ride	
	Pre-Ride	
	Pre-Ride	
	Pre-Ride	
	Pre-Ride	
5 hr	-	
10 hr	Monthly	Clean or replace if necessary
25 hr	3 Months	Check clearance. Adjust if necessary
25 hr	3 Months	Inspect periodically
25 hr	3 Months	Inspect and clean. Replace as needed
25 hr	-	Change engine oil and filter
25 hr	-	Change engine oil and filter
25 hr	3 Months	Check terminals and water level
25 hr	3 Months	Inspect level, change yearly
25 hr	3 Months	Inspect level, change yearly
25 hr	3 Months	Inspect level, change yearly
50 hr	-	Inspect level often, change every 6 months
100 hr	-	Inspect level often, change yearly
100 hr	3 Months	Clean as needed
100 hr	3 Months	Lubricate Zerk fittings
100 hr	3 Months	Inspect, lubricate, adjust
150 hr	3 Months	Inspect, lubricate
150 hr	6 Months	Inspect, adjust, lubricate, replace if needed
150 hr	12 Months	Inspect. Replace if needed
50 hr	12 Months	Check clearance. Adjust if necessary
250 hr	24 Months	Check for leaks. Change fuel filter
250 hr	24 Months	Drain and replace
250 hr	24 Months	Inspect
250 hr	24 Months	Inspect for wear. Apply dielectric grease to connectors subject to water, mud, etc.
250 hr	24 Months	Replace as needed
250 hr	24 Months	Adjust as needed
250 hr	24 Months	Check for leaks and operation
350 hr	36 Months	Drain and change fluid
350 hr	36 Months	Inspect, clean, replace worn parts
350 hr	36 Months	Inspect, replace as needed
350 hr	36 Months	Inspect, adjust as needed



Intimidator Lubrication and Fluid Chart

Factory-filled with and recommend using these fluids

Item	Lube	Amount	Method
Brake Fluid	DOT 3	Fill between min and max	Maintain level between fill lines
Front Differential Oil	Shell Spirax S3 TLV	18 ml	–
Rear Differential Oil	Shell Spirax S4 AX 80w90	550 ml	–
Transmission/ Gearbox Oil	Pennzoil Plat LV MVATF		
Kohler 1000		700 ml	–
Kohler 750			–
Intimidator 800		420 ml	–

Fuse and Relay—800 EFI

Fuses can be found in two locations, on the driver's side of the engine and in a fuse block under the front hood.

The main fuse, located under the seat on the driver's side of the UTV, is a 75 amp fuse.

Fuse Block

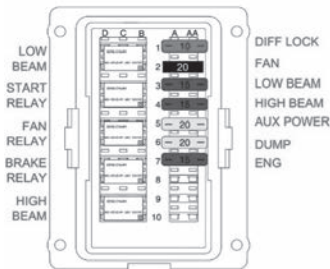

Fuse Chart

Main Fuse (Battery).....	80-amp
Front Engine Fuse, charging system	30-amp
Middle Engine Fuse.....	10-amp
Rear Engine Fuse.....	10-amp
Differential Lock	10-amp
Headlight Low.....	15-amp
Headlight High (if equipped).....	15-amp
Power Port.....	20-amp
Electric Actuator (if equipped).....	20-amp

Relay Block



800 Relay block is found under the hood.

- A- Power Relay
- B- Power Relay
- C- Fuel Pump Relay
- D- Power Relay

Fuse and Relay—Kohler 750 EFI

Fuses can be found in three locations, a main fuse next to the battery, on the passenger side of the engine and under the front hood in a fuse block.

Fuse Block

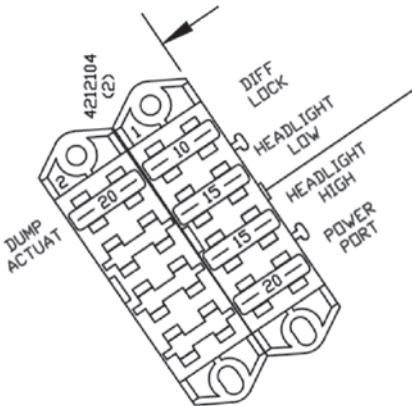

Fuse Chart

Main Fuse (Battery)	80-amp
Front Engine Fuse, charging system	30-amp
Middle Engine Fuse.....	10-amp
Rear Engine Fuse.....	10-amp
Differential Lock	10-amp
Headlight Low.....	15-amp
Headlight High (if equipped).....	15-amp
Power Port.....	20-amp
Electric Actuator (if equipped).....	20-amp

Relay Block

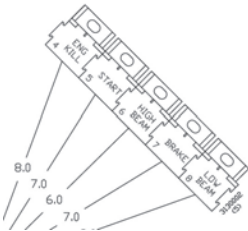

Fuse and Relay— Kohler 1000 Diesel

Fuses can be found in two locations, two main fuses on the driver side of the engine and in a fuse block under the front hood.

Fuse Block

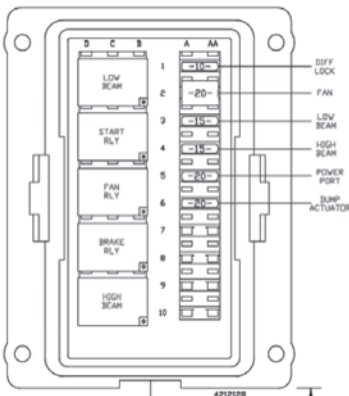

Fuse Chart

Main Fuse (battery)	80-amp
Glow Plugs	50-amp
Differential Lock	10-amp
Fan	15-amp
Headlight Low	15-amp
Headlight High (if equipped).....	15-amp
Power Port.....	20-amp
Electric Actuator (if equipped).....	20-amp

Relay Block

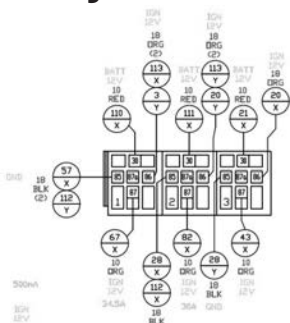

ENGINE OIL

Kohler 750 EFI and Intimidator 800 EFI

Factory-filled with and recommend using Intimidator SYN 5W-40 for both the Intimidator 800 and Kohler 750. Always check and change the oil at intervals outlined in the Periodic Maintenance Chart beginning on page 36.

Pay attention to the oil level. A rise in oil level during cold weather can indicate contaminants collection in the oil sump or crankcase. Change oil immediately if the oil level begins to rise. Monitor the oil level, and if it continues to rise, discontinue use and determine the cause or see your dealer.



Oil Check

The oil dipstick and fill tube is located on the top of the engine.

1. Position the vehicle on level surface. Shift the transmission into “P” (Park) and turn the vehicle off.
2. Let the engine cool so oil has time to drain into sump.
3. Remove the seat.
4. Locate and remove the dipstick. Wipe it dry with a clean cloth.
5. Reinstall the dipstick completely but do not lock it. The dipstick must be inserted completely to keep the angle and depth of the stick consistent.
6. Remove the dipstick and check the oil level. Maintain the oil level in a safe range. Do not overfill.
7. Reinstall the dip stick.
8. Reinstall the seat.

Engine Oil and Filter Change

Always change the oil and filter at the intervals outlined in the Periodic Maintenance Chart. (Pages 36-37)

Always change the oil filter when changing the oil.

1. Position the vehicle on a level surface. Shift the transmission into “P” (Park) and turn the vehicle off.
2. Clean the area around the drain plug and oil fill cap/dipstick.
3. Place a drain pan beneath engine crankcase.

WARNING:

HOT OIL CAN CAUSE BURNS TO SKIN.

4. Remove the 11/16” drain plug under driver.
5. Allow the oil to drain completely.
6. Reinstall the sealing washer on the drain plug. The sealing surfaces on drain plug and crankcase should be clean and free of burrs, nicks or scratches.

7. Reinstall the drain plug and torque to 10 ft-lbs.
8. Place shop towels beneath the oil filter. Using an oil filter wrench, turn the filter counterclockwise to remove it.
9. Using a clean dry cloth, clean the filter sealing surface on the crankcase.
10. Lubricate the o-ring on the new filter with a film of fresh engine oil. Check to make sure the o-ring is in good condition.
11. Install the new filter and turn by hand until the filter gasket contacts the sealing surface, then turn an additional ½ turn.
12. Fill with 2 quarts of new oil. Level should be at top of indicator on dipstick.
13. Reinstall oil fill cap/dipstick and tighten securely.
14. Apply the brakes. Start the engine. Allow it to idle for two minutes.
15. Stop the engine. Inspect for leak.
16. Check the oil level on the dipstick and add oil as necessary to bring the level to the upper safe mark on the dipstick.
17. Reinstall the seat.

ENGINE OIL

Kohler 1000 Diesel

Engine Oil

Factory-filled with and recommended using Intimidator SYN 5W-40. Always check and change the oil at intervals outlined in the Periodic Maintenance Chart beginning on page 36.

Pay attention to the oil level. A rise in oil level during cold weather can indicate contaminants collection in the oil sump or crankcase. Change oil immediately if the oil level begins to rise. Monitor the oil level, and if it continues to rise, stop use and determine the cause or see your dealer.



Oil Check

The dipstick is located on the engine and the fill tube is located behind the driver's seat, between the bed and cab.

1. Position the vehicle on level surface. Shift the transmission into "P" (Park) and turn the vehicle off.
2. Remove the seat.
3. Locate and remove the dipstick. Wipe it dry with a clean cloth.
4. Reinstall the dipstick completely but do not lock it. The dipstick must be inserted completely to keep the angle and depth of the stick consistent.
5. Remove the dipstick and check the oil level. Maintain the oil level in a safe range. Do not overfill.
6. Reinstall the dipstick.
7. Reinstall the seat

Engine Oil and Filter Change

Always change the oil and filter at the intervals outlined in the Periodic Maintenance Chart (Pages 36-37).

Always change the oil filter when changing the oil.

WARNING:

HOT OIL CAN CAUSE BURNS TO SKIN.

1. Position the vehicle on a level surface. Shift the transmission into "P" (Park) and turn the vehicle off.
2. Clean the area around the drain plug and oil fill cap/dipstick.
3. Place a drain pan beneath engine crankcase.
4. Remove the drain plug.
5. Allow the oil to drain completely.
6. Reinstall the sealing washer on the drain plug. The sealing surfaces on drain plug and crankcase should be clean and free of burrs, nicks or scratches.
7. Reinstall the drain plug and torque to 30 ft-lbs.
8. Place shop towels beneath the oil filter. Using an oil filter wrench, turn the filter counterclockwise to remove it.

9. Using a clean dry cloth, clean the filter sealing surface on the crankcase.
10. Lubricate the o-ring on the new filter with a film of fresh engine oil. Check to make sure the o-ring is in good condition.
11. Install the new filter and turn by hand until the filter gasket contacts the sealing surface, then turn an additional ½ turn.
12. Fill with 2.5 quarts of new oil. Level should be at top of indicator on dipstick.
13. Reinstall oil fill cap/dipstick and tighten securely.
14. Bleed the fuel system if needed.
15. Apply the brakes. Start the engine. Allow it to idle for two minutes.
16. Stop the engine. Inspect for leak.
17. Check the oil level on the dipstick and add oil as necessary to bring the level to the upper safe mark on the dipstick.
18. Reinstall the seat.

Spark Plugs Inspection

(Kohler 750 EFI and Intimidator 800 EFI)

Spark plug condition is indicative of engine operation. The spark plug firing end condition should be read after the engine is warmed up and the vehicle is driven at higher speeds. Immediately check the spark plug for color.

WARNING:

A HOT EXHAUST SYSTEM AND ENGINE
CAN CAUSE BURNS

1. Remove the seat. Remove the spark plug cap.
2. Remove the plug by rotating it counterclockwise.
3. Reverse the procedure for spark plug installation.
4. Torque to specification.

Normal Plug

The normal insulator tip is gray, tan or light brown. There will be few combustion deposits. The electrodes are not burned or eroded. This indicates the proper type and heat range for the engine and service. The tip should not be white. A white insulator tip indicates overheating, caused by use of an improper spark plug or incorrect throttle body adjustments.



Wet Fouled Plug

The wet fouled insulator tip is black. A damp oil film covers the firing end. There may be a carbon layer over the entire nose. Generally, the electrodes are not worn. General causes of fouling are excessive oil, use of non-recommended oil or incorrect throttle body adjustments.

COOLING SYSTEM

Kohler 750 EFI

NOTICE:

- Do not travel through water deeper than 12 inches, or to the wheel's center cap. Water can get into the engine and damage the engine and/or electrical components.
- Driving through tall grass or leaves can cause debris to build up on the engine fan, not allowing the engine to cool properly. Always frequently check to be sure the engine fan is free from any debris.
- The Intimidator 750cc is designed for farm, work and light recreational use. The air-cooled motor can withstand water being splashed on the engine but submerging the engine in water can cause the engine to fail. If your vehicle becomes immersed in water, immediately turn the vehicle off and take the vehicle to your dealer before starting the engine to prevent damage.

Kohler 1000 Diesel and Intimidator 800 EFI

Your vehicle's cooling system consists of an aluminum radiator with pressure cap, overflow bottle and connecting hoses attached to the engine. As coolant operating temperature increases, the expanding (heated) coolant is forced out of the radiator, past the pressure cap, and into the overflow bottle. As engine coolant temperature decreases, the contracting (cooled) coolant is drawn back up from the tank, past the pressure cap, and into the radiator.

Some coolant level drop on new vehicles is normal as the system is purging itself of trapped air. Observe coolant levels and maintain as recommended by adding coolant to the overflow bottle.

DANGER:

Radiator coolant is under pressure when the vehicle is hot. Escaping steam can cause burns. NEVER remove the radiator pressure cap while the engine is warm or hot. Always allow the engine to cool before removing the pressure cap.

Adding or Changing Coolant

We recommend coolant to be drained and replaced every two years with premixed, ready-to-use antifreeze that consists of 50% antifreeze and 50% distilled water. Do not dilute premixed antifreeze with water. Keep the overflow bottle filled to the recommended level.

Radiator and Cooling Fan

Always keep the radiator screen clean and free of mud and debris. Do not obstruct or deflect air flow through the radiator by installing unauthorized accessories in front of the radiator or behind the cooling fan. Interference with the radiator air flow can lead to overheating and consequent engine damage. Do not spray the radiator with a high pressure hose as it could damage the radiator fins and impair effectiveness.

The electric cooling fan is on a temperature switch and will automatically turn on when needed. Periodically check the fuse and fan to be sure it is working properly.

Valve Clearance

Excessive valve clearance results in valve noise and insufficient valve clearance results in valve damage and reduced power.

Check the intake and exhaust valve clearances at the distances indicated on page 49 and adjust the valve clearances to specification if necessary.

Valve clearance is to be checked when the engine is cold. The intake and exhaust valves must be checked and adjusted when the piston is at TOP-DEAD_CENTER (TDC) on the compression stroke.

Remove left and right seats, gear shift handle and engine shield.

Remove spark plug cable and spark plug of both cylinders.

Remove the valve cover of both cylinders

1. Distance screws.
2. Valve cover.

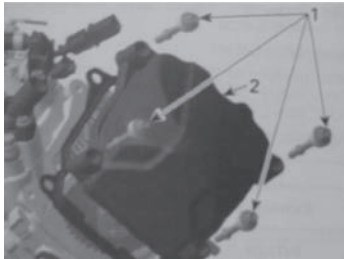

Remove the plug screw and O-ring of magneto cover.
Remove the crankshaft position sensor.

1. Crankshaft position sensor
2. Screw



Valve clearance of cylinder 2

Use a 14 mm Allen key to turn crankshaft until piston 2, rear is at TDC ignition.



When rear piston is at TDC ignition, marks on magneto flywheel "2" and on the magneto cover are aligned.

1. Mark "2" on magneto flywheel
2. Notch on magneto cover
3. Crankshaft position sensor location

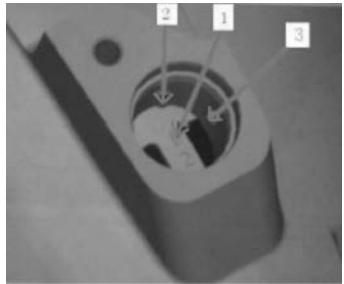

At TDC ignition, the printed marks on the camshaft timing gear have to be parallel to cylinder head base. If not, use an Allen key to turn crankshaft 360°.

1. Printed marks on camshaft timing gear
2. Cylinder head base



Insert the feeler gauge between the valve stem end and adjusting screw on the rocker arm to check the clearance.

If the valve clearance is out of specification, adjust valves as follows.

Valve Clearance	
Intake	0.05 to 0.09 mm
Exhaust	0.10 to 0.15 mm

Use mean valve of exhaust/intake to ensure a proper valve adjustment.

Hold the adjustment screw at the proper position and torque the locking nut.

Repeat the procedure for each valve.

1. Adjustment screw
2. Adjustment nut
3. Feeler gauge

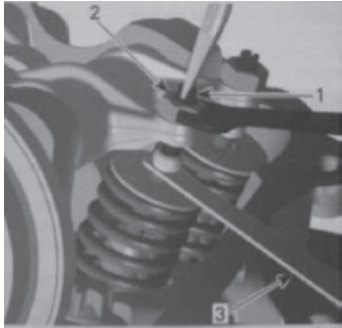

CAUTION:

Securely tighten the locknut after completing adjustment.

Valve clearance adjuster locknut: 12N.m

Valve clearance of cylinder 1

Using a 14 mm Allen key, turn crankshaft 280°

1. Allen key 14 mm
2. Turn crankshaft 280° counterclockwise



Until marks on magneto flywheel "1" and magneto cover are aligned.

1. Mark "1" on magneto flywheel
2. Notch on magneto cover
3. Location of crankshaft position sensor

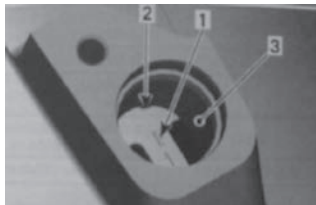

At TDC ignition, the printed marks on the camshaft timing gear have to be parallel to cylinder head base as per following illustration.

TYPICAL

1. Printed marks on camshaft timing gear
2. Cylinder head base



Insert the feeler gauge between the valve stem end and adjusting screw on the rocker arm to check the clearance.

If the valve clearance is out of specification, adjust valves as follows.

Valve Clearance	
Intake	0.05 to 0.09 mm
Exhaust	0.10 to 0.15 mm

Use mean valve of exhaust/intake to ensure a proper valve adjustment.

Hold the adjustment screw at the proper position and torque the locking nut.

Repeat the procedure for each valve.

1. Adjustment screw
2. Adjustment nut
3. Feeler gauge

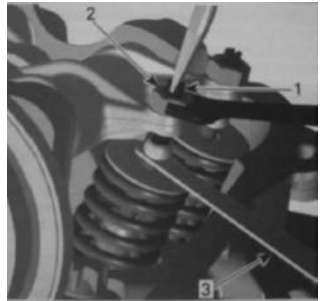

CAUTION:

Securely tighten the locknut after completing adjustment.

Valve clearance adjuster locknut: 12N.m

Install the valve cover of both cylinders, spark plug cable and spark plug of both cylinders, the plug screw and O-ring of magneto cover and the crankshaft position sensor.

Air Filter

Always change the air filter at intervals outlined in the Periodic Maintenance Chart. Service the air filter more frequently if the vehicle is operated in wet conditions, dusty conditions or if the vehicle is operated at high throttle for extended periods.

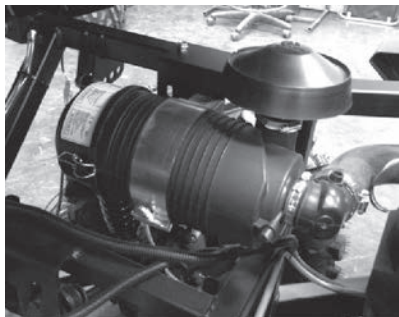

Changing the Air Filter

1. Locate the air filter housing from the back on the UTV, under the cargo bed on the driver's side.
2. Release the two latches to remove the plastic end cap.
3. Pull out the cylinder-shape air filter.
4. Clean or replace filter then reinstall.

Transmission/Gearbox

(Kohler 1000 Diesel and Kohler 750 EFI)

Always check and change the transmission oil at the intervals outlined in the Periodic Maintenance Chart beginning on page 36-37. Refer to the Lubrication and Fluid Recommendations chart for type and capacities (Page 38).

Oil Check

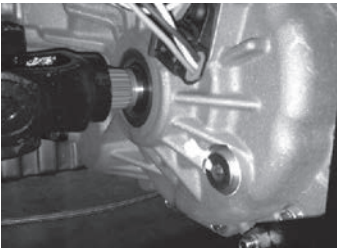

The level check/fill plug is located on the back, passenger side of the gear case. Maintain the oil level even with the bottom of the level check/fill plug hole threads.

1. Position the vehicle on a level surface.
2. Remove the level check, fill plug. Check the oil level.
3. Add the recommended oil as needed (Pages 41-43).
4. Reinstall both fill plugs.

Oil Change



The drain plug is located on the lower front, driver side of the gear case.

1. Position the vehicle on a level surface.
2. Place a drain pan under the gear case.
3. Remove the drain and fill plug. Allow the oil to drain completely.
4. Clean and reinstall the drain plug.
5. Add the recommended oil (Pages 41-43).
6. Reinstall the fill plug.
7. Check for leaks.



Transmission/Gearbox

(Intimidator 800 EFI)

Always check and change the transmission oil at the intervals outlined in the Periodic Maintenance Chart. Refer to the Lubrication and Fluid Recommendations chart for type and capacities (Page 38).

Oil Change

Prior to changing the oil, ensure gearbox is on a level surface. Place a drain pan under the gearbox drain plug area. Clean drain plug area and remove magnetic drain plug with its sealing ring to drain gearbox oil. Remove oil filler screw including its o-ring.

CAUTION: Pay attention not to loosen O-ring on drain plug screw. Wait a while to allow oil flow out of gearbox.

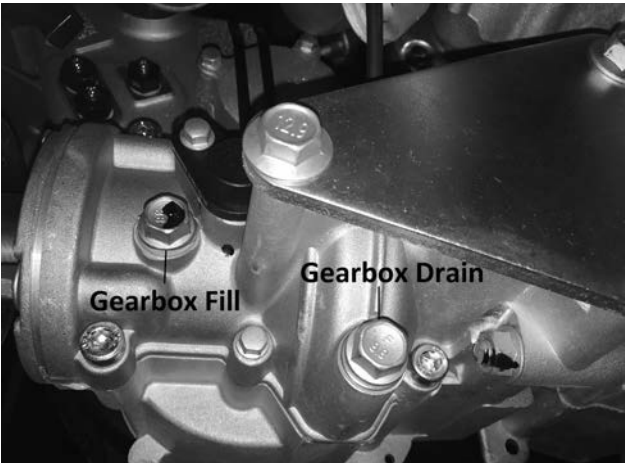

The drain plug is located on the lower passenger side of the gearcase.

1. Position the vehicle on a level surface.
2. Place a drain pan under the gear case.
3. Remove the drain plug. Be sure not to lose the o-ring.
4. Allow the oil to drain completely.
5. Clean and reinstall the drain plug.
6. Remove the fill plug.
7. Add the recommended oil.
8. Reinstall the fill plug.
9. Check for leaks.



Enforcer Information and Specifications

The Enforcer comes standard with a gear lift system using portal box technology to provide a 30% gear reduction at the wheels. This gear reduction makes it so that you don't lose power due to the 4" lift and larger tires. The gear lift system is designed to keep all suspension parts at their factory location. By keeping everything in its factory location, it reduces the stress on your driveline, and allows for the same quality ride. The Portal System is watertight, each axle and spindle are sealed and the lid and cap have their own gaskets. The Portal System is designed to fit on a stock side by side. It is not recommended to be installed with any other system, spring spacer or lift kit. The Portal System comes with a 1-year warranty, and every part in the system is replaceable. Your Portal System does require standard maintenance:

This is a new mechanical system and it does have a break-in period. It is **required** that the oil be changed after the first 100 miles or 5 hours of ride time. You can expect to see tiny metal particles in the oil after the initial oil change due to gear lash and break in of the system. (This is normal.)

Each portal will hold 4 oz. of 80W-90 gear oil. If the vehicle is ridden in mud, water, harsh climates or terrain it is recommended to drain and add new oil to each portal.

Oil Change Procedure

1. Position the vehicle on a level surface.
2. Place a drain pan under the portal box.
3. Using an 8 mm Allen wrench, remove the drain plug on the bottom of the portal box.
4. Allow the oil to drain completely.
5. Clean and reinstall the drain plug.
6. Remove the fill plug, located near the bottom and to the inside of the portal box.
7. Add 4 oz. of 80W-90 gear oil, if you overfill to the point its running out of the fill hole that is okay.
8. Reinstall the fill plug.
9. Wipe up any gear oil that may have spilled and check for leaks.

Adjusting the Shifting Linkage

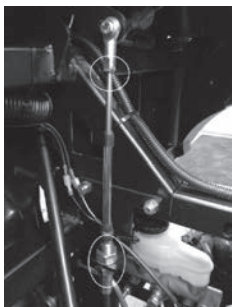

Shift linkage adjustment under hood

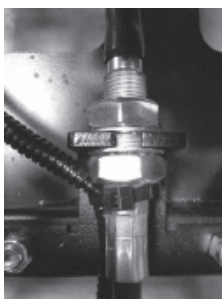

Shift linkage adjustment near gearbox

WARNING: The vehicle's gearshift lever comes properly adjusted from the factory so that the Park gear is fully engaged and will not slip out of Park. During every pre-ride inspection, inspect that the gearshift lever is fully engaged into Park and will not slip out of Park. Have your authorized dealer annually inspect, lubricate, adjust or replace the shifter cable.

If the transmission shifting lever on the dash is not fully engaging "P" (Park) or "L" (Low Range), it needs to be adjusted. This can be done by:

1. Locate the shift linkage bracket on top of the skid plate, on the passenger side of the gearbox.
2. Depending on which way the shifter needs to be adjusted, loosen one of the jam nuts, and then tighten the other jam nut until they both are snug against the shifter bracket. Adjust in 1/8" intervals until the shifting is correct.
3. If needed, further adjustment can be made under the hood on the linkage pictured above.

Differentials

The front and rear differential is what your vehicle's axles are attached to that drives the tires. Always check and change the differential oil at the intervals outlined in the Periodic Maintenance Chart. Maintain the oil level even with the bottom thread of the fill plug hole. Refer to the Front or Rear Differential specifications on the Oil Lubrication and Fluid Recommendations chart for type and capacities (Page 38).



Front Differential Check/Fill Plug

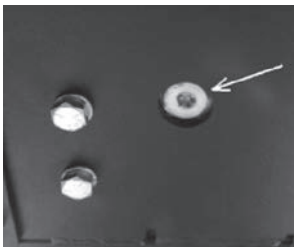

Front Differential Drain Plug

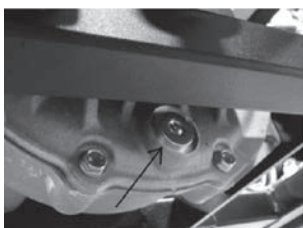

Rear Differential Drain Plug



Rear Differential Check/Fill Plug

Differential Oil Check

On the front differential, the check/fill plug is located on the driver's side rear. On the rear differential, the check/fill plug is located on the passenger side rear.

1. Position the vehicle on a level surface.
2. Place the gearbox in Park.
3. Remove the fill plug. Check the oil level.
4. Add the recommended oil as needed.
5. Reinstall the fill plug.

Differential Oil Change

On the front differential, the drain plug is located on the bottom center. On the rear differential, the drain plug is located on the passenger side.

1. Position the vehicle on a level surface.
2. Place the gearbox in Park.
3. Remove the fill plug.
4. Place a drain pan under the drain plug.
5. Remove the drain plug. Allow the oil to drain completely.
6. Clean and reinstall the drain plug.
7. Reinstall the fill plug.
8. Fill to correct level.
9. Check for leaks.

Continuous Variable Transmission (CVT)

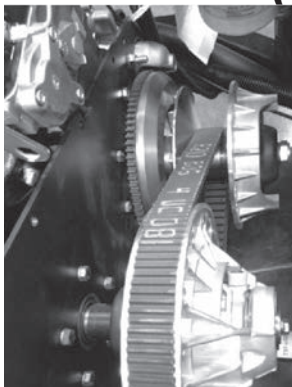

CVT without cover shown



CVT housing shown without vent hoses attached

DANGER:

- Your vehicle is equipped with a CVT, which is a transmission that consists of two clutches and a belt. The CVT rotates at high speeds, creating large amounts of force on clutch components. As an owner, you have the following responsibilities to make sure this system remains safe:
- Turn the vehicle off and remove the ignition key when servicing any part of the CVT system, engine or any component accessible under the seat.
- Do not modify any components of the CVT system. Doing so may reduce its strength so that a failure may occur at high speeds. The CVT system has been precision balanced. Any modification will cause the system to be out of balance, creating a vibration and additional loads on components.
- Always follow all recommended maintenance procedures. Always look for and remove debris inside and around the clutch and vent system when replacing the belt.

NOTICE: Belt slip is responsible for creating excessive heat that destroys belts, wears clutch components and causes outer clutch cover to fail. **To help minimize belt slippage and increase the life of the belt, switch to low range while operating at slower speeds, hauling heavy cargo or towing a trailer.**



NOTICE:

Kohler 750 EFI vehicles have a CVT cover that is designed to keep debris out but not water. **DO NOT** travel through water deeper than 12 inches, or the wheel's center cap. With the CVT belt submerged in water, the belt can slip on the drive pulley, not allowing the vehicle to travel.

CVT Belt Replacement/ Debris Removal

DANGER:

Failure to remove ALL debris when replacing the belt could result in vehicle damage and severe injury.

If the belt fails, always clean any debris from the duct and from the clutch and engine compartments when replacing the belt.

1. Turn vehicles ignition off and remove the key. Be sure the vehicle is in "P" (Park).
2. Remove the seat.
3. Remove CVT cover.
4. Remove all debris wrapped in and around the CVT system and air duct passage.
5. Check for signs of damage to seals on the transmission and engine. See your dealer promptly for service if any seals appear to be damaged.

CVT Drying

Use the following instructions to dry it out before operating.

1. Position the vehicle on a level surface. Put the vehicle in Park.
 - A. On Kohler 1000 diesel models, open the CVT drain on the bottom of the CVT housing. Close once water is drained.
 - B. On Intimidator 800 Models, you drain the CVT by loosening and removing a bolt in the CVT housing. The bolt is located on the bottom of the CVT housing, closest to the rear of the UTV. (See the picture below)

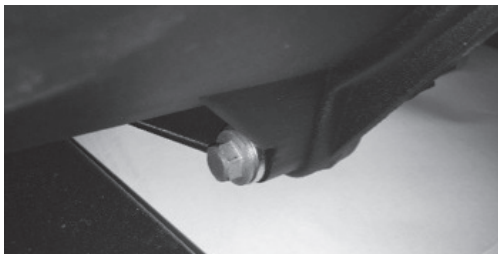

1. Apply the brakes. Start the engine.
2. Apply varying throttle for 15 seconds to expel the moisture and air-dry the belt and clutches. Do not hold throttle wide open.
3. Allow the engine RPM to settle to idle speed.
4. Shift to low range.
5. Drive slow. Test for belt slippage. If belt slips, repeat the process.
6. If belt continues to slip after repeating the process a few times, take the vehicle to your dealer.

Vehicle Submerged in Water

NOTICE:

If your vehicle becomes immersed in water, major engine damage can result. Intimidator warranty does not cover vehicles submerged in water over the floor board. If your vehicle does become submerged above the engine, thorough inspection is necessary and it is recommended to take the vehicle to your dealer before starting the engine.”

If it is impossible to take your vehicle to a dealer before starting the engine, follow the following steps:

1. Tow the vehicle to dry land or at the very least, to water below the footrests.
2. Dry any water present in the air box. Filter replacement required if water is present.
3. Thoroughly dry the air filter.
4. Drain and replace engine oil.
5. Remove the spark plugs (Kohler 750 EFI and Intimidator 800 EFI only). Turn the engine over several times by using the ignition key.
6. Dry the spark plugs then reinstall, or if possible, replace the spark plugs with new ones.
7. Attempt to start the engine. If necessary, repeat the drying procedure.
8. Immediately take the vehicle to your dealer for service.

THROTTLE SYSTEM

If the throttle pedal has excessive play due to either cable stretch or maladjustment, it will cause a delay in throttle response, especially at low engine speed. Also, the throttle may not open fully. If the throttle pedal has no play, the throttle may be hard to control, and the idle speed may be erratic. Check the throttle play periodically and adjust if necessary.

Throttle Pedal Play Inspection

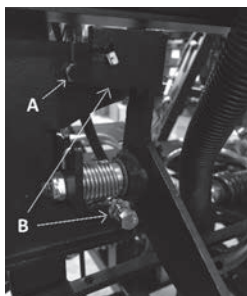

- Put the gearshift level in the Park position.
- Start the engine.
- Measure the distance the throttle pedal moves before the engine begins to pick up speed. Free play should be around 0.5 inches.

Adjusting Slack or Play in the Gas Pedal

Accessible under the hood, against the firewall, the throttle cable on the gas and diesel machines can be adjusted on the engine side and the foot pedal side.

- Adjust the two jam nuts on the cable conduit (A).
- The full throttle stop and the idle stop for the pedal are adjusted by the 5/16" bolts in the mount assembly (B).

Kohler 1000 Diesel

Adjusting the Throttle Pedal Play

- Remove the seat.
- On top of the engine under the roll cage support bar, locate the adjustment screws as seen in the picture on page 63.
- Tighten or loosen bolt A to adjust slack in throttle cable.
- Tighten or loosen bolt B to adjust idle RPM's.

Notice: Be sure that engine RPM's at idle is maintained at the factory setting of around 1,100.

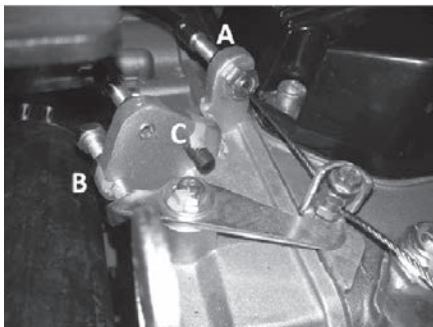

Kohler 1000 Diesel Engine pictured

BATTERY



DANGER:

The Battery emits explosive gases; flame is strictly prohibited. The Battery contains sulfuric acid (electrolyte) which can cause serious burns, so be careful not to make contact with your eyes or skin. If you get battery acid on your skin, wash it off immediately with water. If you get battery acid in your eyes, flush it out immediately with water and then see a doctor.

Keep all flames and sparks, including cigarettes, away from the battery.

Notice:

- The battery requires maintenance.
- Check the battery terminals and distilled water levels monthly.
- Do not allow any battery cell to run dry.
- Keeping the battery terminals coated with dielectric grease or petroleum jelly will prolong its life.



- When connecting the battery, connect the red wire first with the mark (+) and the black wire with the mark (-) of the battery. Be aware that reversing the battery lead wires can harm your UTV, the battery and/or the charging system.

When charging the battery:

- Keep your work area well ventilated.
- Disconnect the vehicle from battery terminals.
- Use 1.8A current for 5-10 hours.
- The maximum charging rate is 9A x 1 hour.

State of Charge	Voltage	Action	Charge Time (Conventional charger at a consistent, standard charge rate)
100%	12.8 - 13 volts	None	None
75 - 100%	12.5 - 12.8 volts	May need slight charge	3 - 6 hours
50 - 75%	12.0 - 12.5 volts	Needs a charge	5 - 11 hours
25 - 50%	11.5 - 12.0 volts	Needs a charge	12 + hours
0 - 25%	11.5 volts or less	Needs a charge with desolating charger	See dealer

Jump Starting

If your vehicle's battery is "run down," it should be removed and charged. If this is not practical, a 12-volt booster battery and jumper cables may be used to start the engine.

DANGER:

Batteries contain sulfuric acid that can cause burns and produce hydrogen gas which is highly explosive. Take care not to touch the positive and negative cables together while connected to the battery. Do not lean over the battery. Do not connect to a frozen battery as it could explode. Do not reverse polarity by connecting a positive (+) to a negative (-), or a battery explosion and serious damage to the electrical system may occur.

NOTICE:

Do not operate the starter continuously for more than 5 seconds, or the starter can overheat and the battery will drop temporarily. Wait 15 seconds between each operation of the starter to let it cool and for the battery to recover power.

Battery Storage

Whenever the vehicle is not in use for a period of three months or more, disconnect negative battery cable from battery after ensuring the battery is fully charged.

A Battery Tender can be left connected during the storage period, and will automatically charge the battery if the voltage drops below a pre-determined point.

Headlights

The headlights are controlled by a three-way switch in the dash. The LED light strips are daytime running lights, the outside set of lights are low-beams, and the inside set of lights are high-beams.

- The angle of the headlight can be adjusted by: adding shims, or washers, behind the bolt on the headlight mounting bracket.

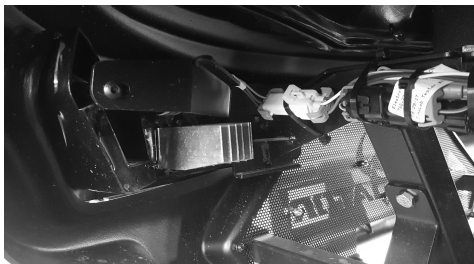

CV Joint Boots

In accordance with the Periodic Maintenance Chart, inspect the joint boots on the front axles, rear axles, tie rod ends and steering rack for damage or deterioration. Replace any damage boot and be sure the joints are greased.

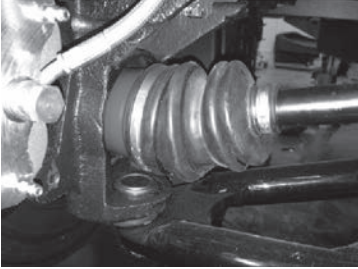

Brakes

The front and rear brakes are hydraulic disc activated by the brake pedal.

Brake Fluid

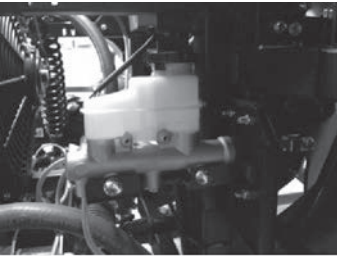

Inspect the level of the brake fluid before each operation. Always keep the fluid level between the minimum and maximum fill line on the reservoir. Change the brake fluid either every two years, any time the fluid becomes contaminated or if the type and brand of the fluid in the reservoir are unknown.

1. Position the vehicle on a level surface and place transmission in "P" (Park).
2. View the brake fluid level at the reservoir in the driver's side wheel well. The level should be between the upper (MAX) and lower (MIN) level lines.

3. If the fluid level is lower than the upper level line, remove cap and add brake fluid to the upper (MAX) line.
4. Reinstall the cap.
5. Apply the brake forcefully for a few seconds and check for fluid leakage around the fittings.

Brake Pressure Switch and Safety Switch

For safety, the brake must be applied to start the Intimidator. The brake pressure switch is located on the master cylinder as shown in the picture below.

Picture 1

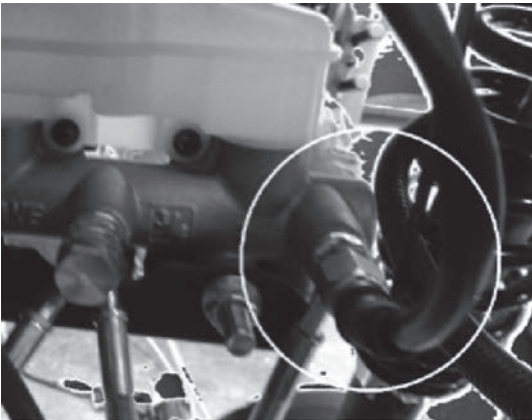

Brake pressure switch pictured

Brake Inspection

1. Check the brake system for fluid leaks.
2. Check the brake pedal for excessive travel or a spongy feel.
3. Check the friction pads for wear, damage and looseness.
4. Inspect the brake disc spline and pad wear surface for excessive wear.
5. Change pads when worn to 3/64" (1 mm).



TIRES

Tires are an important part of the suspension of the vehicle. Tire construction characteristics and inflation pressure can greatly influence vehicle handling. Intimidator, Inc. always recommends that you always replace tires with standard replacement tires. It is also very important to have tires of the same type and height on all axles, and at the same inflation pressure on each axle.

DANGER:

Installation of non-standard tires, use of oversized tires or use of different tread patterns can change or impair the handling of the vehicle and may void your warranty. See Warranty Guideline for details.

Tire Tread Depth

Replace your tires when tread depth is worn to 1/8" (3 mm) or less.

Wheel Lug Nuts

Torque lug nuts to 65 ft-lb.

TIRE PRESSURE AND SIZE CHART

Vehicle Position	Size	Load Rating (lb)	Air Pressure (psi)	Top Speed Rating (mph) @ Max Load
Front Loaded	27x10R14	750	18	10
Rear	27x12R14	1275	22	10
Front Unloaded	27x10R14	680	12	35
Rear	27x12R14	1000	12	35

Steering Wheel Inspection

Check the steering wheel for specified free play and smooth operation at the intervals outlined in the Periodic Maintenance Chart.

1. Position the vehicle on level ground.
2. Lightly turn the steering wheel left and right. There should be no more than 0.5" of free play.
3. If there is excessive free play or strange noises, or the steering feels rough or "catchy," have the steering system inspected by an authorized dealer.

To center your vehicles steering wheel:



1. On level ground, drive straight forward for 30 feet. This is easiest done by driving on a painted line, next to a wall or next to any other straight object.
2. Stop the vehicle. Place the transmission in "P" (Park).
3. Remove the steering wheel cap to expose the steering wheel nut.
4. Remove nut with an impact driver or long socket wrench.
5. With your hands or a rubber mallet, gently knock the back of the steering wheel towards the seat until it is removed. Do not use excessive force or the steering wheel may become damaged or forcefully come off. Do not turn the steering wheel or allow the tires to turn.
6. Reinstall Steering Wheel to center position.
7. Reinstall the steering wheel nut.
8. Reinstall the steering wheel cap.



Power Steering (if equipped)

Kohler 1000 Diesel and Intimidator 800 models can be equipped with optional power steering made by UniSteer Performance Products.

Diagnosis Trouble Code Reading and Code Clearing

1. Verify that your trouble code light is on steady.
2. Next, take your dark purple wire and hold it to a good clean ground. You will have to make sure it is a solid ground to get the LED to blink or flicker, and you may have to use a jumper wire to extend the wire's length. Once you see the LED flicker or blink, wait for LED to start blinking a code.
3. The light will flash in a sequence like 1 and then 123. This code flash would be interpreted as a code 13. The code will repeat itself 3 times and then go to the next code if there is one in the system. You need to wait until all the codes are read and recorded.
4. Turn off the unit and turn back on. Once light is lit and staying on, touch the dark purple wire 6 times in a row to a ground. After the 6 times turn unit off and turn back on. Codes should be cleared with the unit working properly. If not continue to step 5.
5. Double check the codes using steps 1 through 3. Once you know what the codes are you can use this chart to tell where or what the problem may be.
6. Once you have determined what the problem is and make the necessary repairs the unit should work normally. If the light is still on after the repair you will need to clear the codes using step 4.

Trouble Code	Problem	Diagnosis
41-42-43-44-45-51	Electric motor malfunction	Replace Motor Assembly
11-13-14-15	Torque Sensor	Replace Motor Assembly
52-54-55	ECU Malfunction	Change Computer
22	No Engine Input	Change Computer
21-23-24	No Speed Signal	Change Computer
12	Wiring or Electrical	Verify 12 volts at small red wire. Verify good ground. Solder all connections. Check for bad connections or broken wires.

Alignment

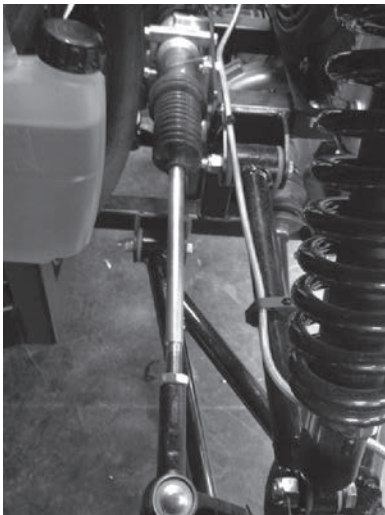

Though a tire alignment should be done by your dealer, the steps are provided below

To adjust front tire alignment:

1. Make sure the steering wheel alignment is correct.
2. Stop the vehicle on a level surface with the tires straight forward.
3. Place the transmission in "P" (Park).
4. Measure the distance between centerline-to-centerline forward (front) of the tires at hub height.
5. Measure the distance between centerline-to-centerline behind (rear) the tires at hub height.
6. Front distance should be 0 inches to 0.25 inches shorter than rear distance. If not, adjust tie rod length.

NOTICE:

Installing unauthorized accessories, such as larger tires or a lift kit, may damage the vehicle and could void the warranty. See your vehicle's warranty information for details.



STORAGE AND MAINTAINING APPEARANCE

Washing the Vehicle

Keeping your vehicle clean will not only improve its appearance but it can also extend the life of various components.

NOTICE:

High water pressure may damage components, including wheel bearings, radiator, transmission seals, brakes, plastic panels, safety labels, electrical switches, electrical components and wiring. Wash the vehicle by hand or with a garden hose, using mild soap.

NOTICE:

Certain products, including insect repellents and chemicals, will damage plastic surfaces. Do not allow these types of products to contact the vehicle. Clean vehicle with automotive soap and water.

NOTICE:

Mud can stain the vehicles seat and plastic. Immediately wash mud off vehicle with mild soap and water.

Tips

- Avoid the use of harsh cleaners as they can scratch the finish.
- Use Goo Gone to remove sticker residue from plastic.
- Do not use a power washer to clean the vehicle.
- Do not use medium to heavy duty compounds on the finish.
- Always use clean, microfiber cloths, towels and pads for cleaning and polishing. Old and reused cloths and pads may contain dirt particles that will scratch the surface.
- Grease all zerk fittings immediately after washing. Allow the engine to run for a while to evaporate any water that may have entered the engine or exhaust system.
- If any informational or warning label becomes illegible or comes off, contact your Intimidator dealer to order a replacement label.

Storage

NOTICE:

It is not recommended to store vehicle in direct sunlight.

Preparation for Storage

1. Clean the entire vehicle thoroughly.
2. Add Kohler PRO Series fuel treatment or equivalent to fuel tank.
3. Run the engine for five minutes to warm the oil, shut it off and drain the oil.
4. Put in fresh engine oil.
5. Remove spark plugs and pour about 1 oz. of engine oil into cylinder(s). Replace spark plugs and crank engine slowly to distribute oil.
6. Put boards under all tires to keep dampness away from the rubber.
7. Lubricate throttle cable wire.
8. Remove the battery, and store it where it will not be exposed to direct sunlight, moisture, or freezing temperatures. See pages 63-65 for further information.
9. Tie a plastic bag over the exhaust pipe, CVT intake and CVT exhaust to prevent moisture or small animals from entering.
10. Put a cover over the vehicle to keep dust and dirt from collecting on it.

Removal from Storage

1. Remove the plastic bags from the exhaust pipe, CVT intake and CVT exhaust.
2. Clean the terminals of the battery, charge the battery if necessary, and install it in the vehicle.
3. Make sure the spark plugs are tight and plug wires are attached (Kohler 750 EFI).
4. Fill the fuel tank with fuel.
5. Check all the points listed in the "Pre-ride checklist" section.
6. Lubricate as indicated.



TRANSPORTING YOUR INTIMIDATOR

DANGER:

When trailering your vehicle, ALWAYS put the transmission in Park AND secure the vehicle to the trailer by tying the frame of the Intimidator to the trailer with suitable straps or chains. ***Do not attach a strap or chain to the suspension arms.***

ACCESSORIES

Visit www.baddawgaccessories.com for a complete list of genuine Intimidator accessories.

GAS SPECIFICATIONS

750G GAS CLASSIC

CORE COMPONENTS

Frame	Powder-Coated Fusion-Bonded Solid Steel Bridge Frame
Body	Automotive Quality Acrylic Plastic
Front Tires	27x10x14 - 6 ply
Rear Tires	27x12x14 - 6 ply
Wheels	14" Wheels
Front Suspension	Dual A-Arm Independent
Rear Suspension	Dual A-Arm Independent
Steering	Rack And Pinion
Braking System	4-Wheel Hydraulic Disc
Parking System	2-Wheel Gear Lock
Seating	3 Forward Facing Occupant Bench Seat
Bed Dump	Manual With Gas Assist
Auxiliary Power	12 Volt Auxiliary Plug
Hitch	2" Receiver Standard
Cargo Bed Space	36x56.5x13
Fuel Capacity	9 Gallons
Warranty	3-Year Limited

DRIVE SYSTEM

Engine	750cc Kohler Fuel-Injected Engine
Bore x Stroke	83mm X 69.9mm
Compression Ratio	9.1:1
Displacement	750cc
Carburetor	Electronic Fuel-Injected Throttle Body
Final Drive	Shaft Driven
Automatic CVT	Low/Hi/Neutral/Reverse/Park
Drive System	2WD, Electronic 4WD Selection
Cooling	Air Circulation
Starting	Electric Start
MAX Torque Engine	40.4 FT. LB @ 2800 RPM
Fuel Type	87 Octane Gasoline (10% Ethanol Max)
Engine Oil Type	Intimidator SYN 5W-40
Speed	Up To 35 MPH

MEASUREMENTS

Weight	1,571 lbs.
Length	113"
Width	63"
Height	78"
Turning Radius	103"
Wheelbase	77"
Frame Clearance	12"
Suspension Travel	10" Total Suspension Travel
Cargo Bed Capacity	1,200 lbs.
Vehicle Payload	1,600 lbs.
GVWR	3,300 lbs.
Towing Capacity	2,100 lbs.

SAFETY

Protection	1.75" Diameter Tubing Five-Piece ROPS
Front Protection	1.75" Diameter Tubing Bumper/Brush Guard
Passenger Restraints	3-Point DOT-Approved Restraint Belts
Cab Nets	Standard on Every Unit
Shift Indicator	5-Position Gear Indicator
Headlights	Standard on Every Unit
Brake/Taillight	Standard on Every Unit

XD4 PACKAGE INCLUDES: 14-inch aluminum wheels, Journey tires, electric bed dump, 2-inch front receiver hitch. Available in OD military green, orange, metallic black, or Realtree™ camo upgrade.



GAS SPECIFICATIONS

750G GAS CREW

CORE COMPONENTS

Frame	Powder-Coated Fusion-Bonded Solid Steel Bridge Frame
Body	Automotive Quality Acrylic Plastic
Front Tires	27x10x14 - 6 ply
Rear Tires	27x12x14 - 6 ply
Wheels	14" Wheels
Front Suspension	Dual A-Arm Independent
Rear Suspension	Dual A-Arm Independent
Steering	Rack And Pinion
Braking System	4-Wheel Hydraulic Disc
Parking System	2-Wheel Gear Lock
Seating	6 Forward Facing Occupant Double Bench Seat
Bed Dump	Manual With Gas Assist
Auxiliary Power	12 Volt Auxiliary Plug
Hitch	2" Receiver Standard
Cargo Bed Space	36x56.5x13
Fuel Capacity	9 Gallons
Warranty	3-Year Limited

DRIVE SYSTEM

Engine	750cc Kohler Fuel-Injected Engine
Bore x Stroke	83mm X 69.9mm
Compression Ratio	9.1:1
Displacement	750cc
Carburetor	Electronic Fuel-Injected Throttle Body
Final Drive	Shaft Driven
Automatic CVT	Low/Hi/Neutral/Reverse/Park
Drive System	2WD, Electronic 4WD Selection
Cooling	Air Circulation
Starting	Electric Start
MAX Torque Engine	40.4 FT. LB @ 2800 RPM
Fuel Type	87 Octane Gasoline (10% Ethanol Max)
Engine Oil Type	Intimidator SYN 5W-40
Speed	Up To 33 MPH

MEASUREMENTS

Weight	1,834 lbs.
Length	149"
Width	63"
Height	78"
Wheelbase	111"
Frame Clearance	12"
Suspension Travel	10" Total Suspension Travel
Cargo Bed Capacity	1,000 lbs.
Vehicle Payload	1,466 lbs.
GVWR	3,300 lbs.
Towing Capacity	2,100 lbs.

SAFETY

Protection	1.75" Diameter Tubing Five-Piece ROPS
Front Protection	1.75" Diameter Tubing Bumper/Brush Guard
Passenger Restraints	3-Point DOT-Approved Restraint Belts
Cab Nets	Standard on Every Unit
Shift Indicator	5-Position Gear Indicator
Headlights	Standard on Every Unit
Brake/Taillight	Standard on Every Unit

XD4 PACKAGE INCLUDES: 14-inch aluminum wheels, Journey tires, electric bed dump, 2-inch front receiver hitch. Available in OD military green, orange, metallic black, or Realtree™ camo upgrade.

GAS SPECIFICATIONS

750G GAS TRUCK

CORE COMPONENTS

Frame	Powder-Coated Fusion-Bonded Solid Steel Bridge Frame
Body	Automotive Quality Acrylic Plastic
Front Tires	27x10x14 - 6 ply
Rear Tires	27x12x14 - 6 ply
Wheels	14" Wheels
Front Suspension	Dual A-Arm Independent
Rear Suspension	Dual A-Arm Independent
Steering	Rack And Pinion
Braking System	4-Wheel Hydraulic Disc
Parking System	2-Wheel Gear Lock
Seating	3 Forward Facing Occupant Bench Seat
Auxiliary Power	12 Volt Auxiliary Plug
Hitch	2" Receiver Standard
Cargo Bed Space	70x60x14
Fuel Capacity	9 Gallons
Warranty	3-Year Limited

DRIVE SYSTEM

Engine	750cc Kohler Fuel-Injected Engine
Bore x Stroke	83mm X 69.9mm
Compression Ratio	9.1:1
Displacement	750cc
Carburetor	Electronic Fuel-Injected Throttle Body
Final Drive	Shaft Driven
Automatic CVT	Low/Hi/Neutral/Reverse/Park
Drive System	2WD, Electronic 4WD Selection
Cooling	Air Circulation
Starting	Electric Start
MAX Torque Engine	40.4 FT. LB @ 2800 RPM
Fuel Type	87 Octane Gasoline (10% Ethanol Max)
Engine Oil Type	Intimidator SYN 5W-40
Speed	Up To 33 MPH

MEASUREMENTS

Weight	1,725 lbs.
Length	149"
Width	63"
Height	78"
Wheelbase	111"
Frame Clearance	12"
Suspension Travel	10" Total Suspension Travel
Cargo Bed Capacity	1,200 lbs.
Vehicle Payload	1,575 lbs.
GVWR	3,300 lbs.
Towing Capacity	2,100 lbs.

SAFETY

Protection	1.75" Diameter Tubing Five-Piece ROPS
Front Protection	1.75" Diameter Tubing Bumper/Brush Guard
Passenger Restraints	3-Point DOT-Approved Restraint Belts
Cab Nets	Standard on Every Unit
Shift Indicator	5-Position Gear Indicator
Headlights	Standard on Every Unit
Brake/Taillight	Standard on Every Unit

XD4 PACKAGE INCLUDES: 14-inch aluminum wheels, Journey tires, 2-inch front receiver hitch. Available in OD military green, orange, metallic black, or Realtree™ camo upgrade.



GAS SPECIFICATIONS

800G GAS CLASSIC

CORE COMPONENTS

Frame	Powder-Coated Fusion-Bonded Solid Steel Bridge Frame
Body	Automotive Quality Acrylic Plastic
Front Tires	27x10x14 - 6 ply
Rear Tires	27x12x14 - 6 ply
Wheels	14" Wheels
Front Suspension	Dual A-Arm Independent
Rear Suspension	Dual A-Arm Independent
Steering	Rack And Pinion
Braking System	4-Wheel Hydraulic Disc
Parking System	2-Wheel Gear Lock
Seating	3 Forward Facing Occupant Bench Seat
Bed Dump	Manual With Gas Assist
Auxiliary Power	12 Volt Auxiliary Plug
Hitch	2" Receiver Standard
Cargo Bed Space	36x56.5x13
Fuel Capacity	9 Gallons
Warranty	1-Year Bumper to Bumper

DRIVE SYSTEM

Displacement	800cc
Carburetor	Electronic Fuel-Injected Throttle Body
Final Drive	Shaft Driven
Automatic CVT	Low/Hi/Neutral/Reverse/Park
Drive System	2WD, Electronic 4WD Selection
Cooling	Liquid
Starting	Electric Start
MAX Horsepower	65
MAX Torque Engine	40.4 FT. LB @ 2800 RPM
Fuel Type	87 Octane Gasoline (10% Ethanol Max) 91+ Recommended
Engine Oil Type	Intimidator SYN 5W-40
Speed	Up To 60 MPH

MEASUREMENTS

Weight	1,602 lbs.
Length	113"
Width	63"
Height	78"
Turning Radius	103"
Wheelbase	77"
Frame Clearance	12"
Suspension Travel	10" Total Suspension Travel
Cargo Bed Capacity	1,200 lbs.
Vehicle Payload	1,600 lbs.
GVWR	3,300 lbs.
Towing Capacity	2,100 lbs.

SAFETY

Protection	1.75" Diameter Tubing Five-Piece ROPS
Front Protection	1.75" Diameter Tubing Bumper/Brush Guard
Passenger Restraints	3-Point DOT-Approved Restraint Belts
Cab Nets	Standard on Every Unit
Shift Indicator	5-Position Gear Indicator
Headlights	Standard on Every Unit
Brake/Taillight	Standard on Every Unit

XD4 PACKAGE INCLUDES: 14-inch aluminum wheels, Journey tires, electric bed dump, 2-inch front receiver hitch. Available in OD military green, orange, metallic black, or Realtree™ camo upgrade.

XD SPORT PACKAGE INCLUDES: 14-inch aluminum wheels, Journey tires, electric bed dump, 2-inch front receiver hitch, Vantage 4000 winch, King Ranch seat, ELKA shocks, power steering. Available in metallic black.

GAS SPECIFICATIONS

800G GAS CREW

CORE COMPONENTS

Frame	Powder-Coated Fusion-Bonded Solid Steel Bridge Frame
Body	Automotive Quality Acrylic Plastic
Front Tires	27x10x14 - 6 ply
Rear Tires	27x12x14 - 6 ply
Wheels	14" Wheels
Front Suspension	Dual A-Arm Independent
Rear Suspension	Dual A-Arm Independent
Steering	Rack And Pinion
Braking System	4-Wheel Hydraulic Disc
Parking System	2-Wheel Gear Lock
Seating	6 Forward Facing Occupant Double Bench Seat
Bed Dump	Manual With Gas Assist
Auxiliary Power	12 Volt Auxiliary Plug
Hitch	2" Receiver Standard
Cargo Bed Space	36x56.5x13
Fuel Capacity	9 Gallons
Warranty	1-Year Bumper to Bumper

DRIVE SYSTEM

Displacement	800cc
Carburetor	Electronic Fuel-Injected Throttle Body
Final Drive	Shaft Driven
Automatic CVT	Low/Hi/Neutral/Reverse/Park
Drive System	2WD, Electronic 4WD Selection
Cooling	Liquid
Starting	Electric Start
MAX Horsepower	65
MAX Torque Engine	55 FT. LB
Fuel Type	87 Octane Gasoline (10% Ethanol Max) 91+ Recommended
Engine Oil Type	Intimidator SYN 5W-40
Speed	Up To 60 MPH

MEASUREMENTS

Weight	1,850 lbs.
Length	149"
Width	63"
Height	78"
Wheelbase	111"
Frame Clearance	12"
Suspension Travel	10" Total Suspension Travel
Cargo Bed Capacity	1,200 lbs.
Vehicle Payload	1,600 lbs.
GVWR	3,300 lbs.
Towing Capacity	2,100 lbs.

SAFETY

Protection	1.75" Diameter Tubing Five-Piece ROPS
Front Protection	1.75" Diameter Tubing Bumper/Brush Guard
Passenger Restraints	3-Point DOT-Approved Restraint Belts
Cab Nets	Standard on Every Unit
Shift Indicator	5-Position Gear Indicator
Headlights	Standard on Every Unit
Brake/Taillight	Standard on Every Unit

XD4 PACKAGE INCLUDES: 14-inch aluminum wheels, Journey tires, electric bed dump, 2-inch front receiver hitch. Available in OD military green, orange, metallic black, or Realtree™ camo upgrade.



GAS SPECIFICATIONS

800G CLASSIC ENFORCER

CORE COMPONENTS

Frame	Powder-Coated Fusion-Bonded Solid Steel Bridge Frame
Body	Automotive Quality Acrylic Plastic
Front Tires	32x10x15 – 6 Ply
Rear Tires	32x10x15 – 6 Ply
Wheels	15" Aluminum Wheels
Front Suspension	Dual A-Arm Independent, Portal Box Gear Lift
Rear Suspension	Dual A-Arm Independent, Portal Box Gear Lift
Steering	Rack and Pinion W/ Electronic-Assisted Power Steering
Braking System	4-Wheel Hydraulic Disc
Parking System	2-Wheel Gear Lock
Seating	3 Forward Facing Occupant Bench Seat
Bed Dump	Manual W/ Gas Assist
Auxiliary Power	12 Volt Auxiliary Plug
Hitch	2" Receiver Standard
Cargo Bed Space	36x56.5x13
Fuel Capacity	9 Gallons
Warranty	1-Year Bumper to Bumper

DRIVE SYSTEM

Displacement	800cc
Carburetor	Electronic Fuel-Injected Throttle Body
Final Drive	Shaft Driven
Automatic CVT	Low/High/Neutral/Reverse/Park
Drive System	2WD, Electronic 4WD Selection
Cooling	Liquid
Starting	Electric Start
MAX Horsepower	65
Fuel Type	87 Octane Gasoline (10% Ethanol Max) 91+ Recommended
Engine Oil	Intimidator SYN 5W-40
Speed	Up to 50 MPH

MEASUREMENTS

Weight	1,819 Lbs.
Length	117"
Width	72"
Height	83"
Wheelbase	77 ¾"
Frame Clearance	18"
Suspension Travel	10" Total Suspension Travel
Cargo Bed Capacity	1,000 Lbs.
Vehicle Payload	1,400 Lbs.
GVWR	3,300 Lbs.
Towing Capacity	2,300 Lbs.

SAFETY

Protection	1.75" Diameter Tubing Five-Piece ROPS
Front Protection	1.75" Diameter Tubing Bumper/Brush Guard
Passenger Restraints	3-Point DOT-Approved Restraint Belts
Cab Nets	Standard on Every Unit
Shift Indicator	5-Position Gear Indicator
Headlights	Standard on Every Unit
Brake/Taillight	Standard on Every Unit

ENFORCER PACKAGE INCLUDES: Portal box gear lift, ELKA Shocks, and power steering.
Available in OD military green, orange, metallic black, or Realtree™ camo upgrade.

DIESEL SPECIFICATIONS

1000D CLASSIC SPECIFICATIONS

CORE COMPONENTS

Frame	Powder-Coated Fusion-Bonded Solid Steel Bridge Frame
Body	Automotive Quality Acrylic Plastic
Front Tires	27x10x14 - 6 ply
Rear Tires	27x12x14 - 6 ply
Wheels	14" Wheels
Front Suspension	Dual A-Arm Independent
Rear Suspension	Dual A-Arm Independent
Steering	Rack And Pinion
Braking System	4-Wheel Hydraulic Disc
Parking System	2-Wheel Gear Lock
Seating	6 Forward Facing Occupant Double Bench Seat
Bed Dump	Manual With Gas Assist or Electric
Auxiliary Power	12 Volt Auxiliary Plug
Hitch	2" Receiver Standard
Cargo Bed Space	36x56.5x13
Fuel Capacity	9 Gallons
Warranty	3-Year Limited

DRIVE SYSTEM

Engine	Kohler Diesel Engine
Bore x Stroke	75mm X 77.6
Compression Ratio	22, 8:1
Displacement	1000cc
Carburetor	Fuel Injection (glow plug assisted)
Final Drive	Shaft Driven
Automatic CVT	Low/Hi/Neutral/Reverse/Park
Drive System	2WD, Electronic 4WD Selection
Cooling	Liquid Pump Circulation with Electric Fan
Ignition	Electric Start
MAX Horsepower	Approximately 24HP
Fuel Type	Diesel (meets ASTM D-975-1D or 2D, EN590, or equivalent)
Engine Oil Type	Intimidator SYN 5W-40
Speed	Up To 35 MPH

MEASUREMENTS

Weight	1,695 lbs.
Length	113"
Width	63"
Height	78"
Turning Radius	103"
Wheelbase	77"
Ground Clearance	10.5"
Frame Clearance	12"
Suspension Travel	10" Total Suspension Travel
Cargo Bed Capacity	1,200 lbs.
Vehicle Payload	1,600 lbs.
GVWR	3,300 lbs.
Towing Capacity	2,100 lbs.

SAFETY

Protection	1.75" Diameter Tubing Five-Piece ROPS
Front Protection	1.75" Diameter Tubing Bumper/Brush Guard
Passenger Restraints	3-Point DOT-Approved Restraint Belts
Foot Restraint	Standard on Every Unit
Shift Indicator	5-Position Gear Indicator
Headlights	Standard on Every Unit
Brake/Taillight	Standard on Every Unit

XD4 PACKAGE INCLUDES: 14-inch aluminum wheels, Journey tires, electric bed dump, 2-inch front receiver hitch. Available in OD military green, orange, metallic black, or Realtree™ camo upgrade.



DIESEL SPECIFICATIONS

1000D CREW SPECIFICATIONS

CORE COMPONENTS

Frame	Powder-Coated Fusion-Bonded Solid Steel Bridge Frame
Body	Automotive Quality Acrylic Plastic
Front Tires	27x10x14 - 6 ply
Rear Tires	27x12x14 - 6 ply
Wheels	14" Wheels
Front Suspension	Dual A-Arm Independent
Rear Suspension	Dual A-Arm Independent
Steering	Rack And Pinion
Braking System	4-Wheel Hydraulic Disc
Parking System	2-Wheel Gear Lock
Seating	3 Forward Facing Occupant Bench Seat
Bed Dump	Manual With Gas Assist or Electric
Auxiliary Power	12 Volt Auxiliary Plug
Hitch	2" Receiver Standard
Cargo Bed Space	36x56.5x13
Fuel Capacity	9 Gallons
Warranty	3-Year Limited

DRIVE SYSTEM

Engine	Kohler Diesel Engine
Bore x Stroke	75mm X 77.6
Compression Ratio	22, 8:1
Displacement	1000cc
Carburetor	Fuel Injection (glow plug assisted)
Final Drive	Shaft Driven
Automatic CVT	Low/Hi/Neutral/Reverse/Park
Drive System	2WD, Electronic 4WD Selection
Cooling	Liquid Pump Circulation with Electric Fan
Ignition	Electric Start
MAX Horsepower	Approximately 24HP
Fuel Type	Diesel (meets ASTM D-975-1D or 2D, EN590, or equivalent)
Engine Oil Type	Intimidator SYN 5W-40
Speed	Up To 33 MPH

MEASUREMENTS

Weight	1,952 lbs.
Length	149"
Width	63"
Height	78"
Wheelbase	111"
Ground Clearance	10.5"
Frame Clearance	12"
Suspension Travel	10" Total Suspension Travel
Cargo Bed Capacity	1,000 lbs.
Vehicle Payload	1,348 lbs.
GVWR	3,300 lbs.
Towing Capacity	2,100 lbs.

SAFETY

Protection	1.75" Diameter Tubing Five-Piece ROPS
Front Protection	1.75" Diameter Tubing Bumper/Brush Guard
Passenger Restraints	3-Point DOT-Approved Restraint Belts
Foot Restraint	Standard on Every Unit
Shift Indicator	5-Position Gear Indicator
Headlights	Standard on Every Unit
Brake/Taillight	Standard on Every Unit

XD4 PACKAGE INCLUDES: 14-inch aluminum wheels, Journey tires, electric bed dump, 2-inch front receiver hitch. Available in OD military green, orange, metallic black, or Realtree™ camo upgrade.

DIESEL SPECIFICATIONS

1000D TRUCK SPECIFICATIONS

CORE COMPONENTS

Frame	Powder-Coated Fusion-Bonded Solid Steel Bridge Frame
Body	Automotive Quality Acrylic Plastic
Front Tires	27x10x14 - 6 ply
Rear Tires	27x12x14 - 6 ply
Wheels	14" Wheels
Front Suspension	Dual A-Arm Independent
Rear Suspension.....	Dual A-Arm Independent
Steering	Rack And Pinion
Braking System	4-Wheel Hydraulic Disc
Parking System	2-Wheel Gear Lock
Seating.....	3 Forward Facing Occupant Bench Seat
Auxiliary Power	12 Volt Auxiliary Plug
Hitch	2" Receiver Standard
Cargo Bed Space.....	70x60x14
Fuel Capacity	9 Gallons
Warranty	3-Year Limited

DRIVE SYSTEM

Engine	Kohler Diesel Engine
Bore x Stroke	75mm X 77.6
Compression Ratio.....	22, 8:1
Displacement.....	1000cc
Carburetor	Fuel Injection (glow plug assisted)
Final Drive	Shaft Driven
Automatic CVT	Low/Hi/Neutral/Reverse/Park
Drive System	2WD, Electronic 4WD Selection
Cooling.....	Liquid Pump Circulation with Electric Fan
Ignition.....	Electric Start
MAX Horsepower	Approximately 24HP
Fuel Type	Diesel (meets ASTM D-975-1D or 2D, EN590, or equivalent)
Engine Oil Type	Intimidator SYN 5W-40
Speed	Up To 33 MPH

MEASUREMENTS

Weight	1,843 lbs.
Length.....	149"
Width	63"
Height	78"
Wheelbase	111"
Ground Clearance	10.5"
Frame Clearance	12"
Suspension Travel.....	10" Total Suspension Travel
Cargo Bed Capacity	1,200 lbs.
Vehicle Payload.....	1,457 lbs.
GVWR	3,300 lbs.
Towing Capacity	2,100 lbs.

SAFETY

Protection	1.75" Diameter Tubing Five-Piece ROPS
Front Protection	1.75" Diameter Tubing Bumper/Brush Guard
Passenger Restraints	3-Point DOT-Approved Restraint Belts
Foot Restraint	Standard on Every Unit
Shift Indicator	5-Position Gear Indicator
Headlights	Standard on Every Unit
Brake/Taillight	Standard on Every Unit

XD4 PACKAGE INCLUDES: 14-inch aluminum wheels, Journey tires, 2-inch front receiver hitch. Available in OD military green, orange, metallic black, or Realtree™ camo upgrade.



TROUBLESHOOTING

For service questions and parts please contact an authorized dealer. Authorized Intimidator dealers can be found by visiting: <http://intimidatorutv.com/dealer/home/>

Trouble	Cause	
Engine is difficult to start or will not start	Key switch is not in the proper position	
	Wiring	
	Starter Switch or Solenoid	
	No or low fuel	
	Improper or stale fuel	
	Water or dirt in the fuel system	
	Air in the fuel system (Diesel only)	
	Fuel hose or fuel filter clogged or damaged	
	Air filter is clogged	
	Spark plug defective (Kohler 750 only)	
	Engine oil viscosity is wrong	
	Battery becomes weak and the engine does not turn over quick enough	
	Brake pedal is not engaged	
	Parking Brake safety switch	
	Insufficient engine power	Faulty glow plugs (Diesel only)
Brake pressure switch has malfunctioned		
Fuse is blown		
Engine stops suddenly	Battery is dead	
	Loose battery or solenoid connections	
	Insufficient or dirty fuel	
Engine stops suddenly	Air cleaner is clogged	
	Engine is cold	
	Spark plug defective (Kohler 750 only)	
Engine stops suddenly	Insufficient fuel	
	Fuel pump improperly working	
	Engine is cold	

Countermeasure

Make sure the key is in "ON" position

Clean corroded connections and tighten loose connections

By-pass switch or solenoid with a jumper wire. If starter cranks normally, replace faulty components

Replenish fuel

Replace fuel and consult your authorized dealer

Bleed the fuel system

Clean or replace fuel lines, and consult your authorized dealer

Clean or replace air filter

Adjust the spark plug gap or replace the spark plug

Check spark plug wire connection

Use oils of different viscosities, depending on ambient temperatures

Clean battery cables and terminals

Charge the battery

In cold weather, always remove the battery from the engine, charge and store it indoors. Install it on the machine only when the machine is going to be used

Apply pressure to the brake when starting

Replace brake switch (located near master cylinder).

Check wire connection

Replace brake switch (located near master cylinder)

Check fuse box under the hood and the main fuse, which is located next to the battery

Charge or replace the battery

Check all connections and tighten

Check the fuel system. Replace fuel filter if necessary

Clean or replace the air cleaner

Allow time for engine to warm before driving

Adjust the spark plug gap or replace it

Refuel

Check that the wires are connected properly. If needed, replace pump

Allow time for engine to warm before driving



TROUBLESHOOTING

Trouble	Cause
Rough running engine	Spark plug defective (Kohler 750 only)
	Engine just started and had not warmed up
	Engine is cold
	High tension cord defective
	Ignition coil defective
	Fuel hose or fuel filter clogged or damaged
	Improper or stale fuel
	Air filter is clogged
Exhaust fumes are colored (black, dark, gray)	Overload
	Low grade fuel is used
	Air filter is clogged
Exhaust fumes are colored (white or blue)	Excessive engine oil
	Piston ring is worn or stuck
Engine overheats	Engine is overloaded
	Engine oil is insufficient
	Engine too muddy
	Engine air intake, or fan, is blocked
Engine diagnostic light comes on	—
Engine will not idle	Spark plug defective (Kohler 750 only)
	Engine is cold
	Fuel injectors dirty
Difficult to shift	Engine RPM's too high
	Shifter cable stretched
	Shifting cable dirty or rusted

CVT TROUBLESHOOTING

Trouble	Cause
CVT belt is wearing too quickly	Towing/pushing (plowing)
	Heavy payload
	Driving up steep inclines
	Stuck in mud or snow
	Climbing over large objects from a stopped position
	Aggressive driving
	Insufficient warm-up at low ambient temperatures
Acceleration is not smooth from dead-stop	Engine just started and had not warmed up

Countermeasure

Adjust the spark plug gap or replace it

Allow the engine to run for a few minutes

Allow the engine to run for a few minutes

Allow time for engine to warm before driving

Consult your authorized dealer

Clean or replace fuel lines. Consult your authorized dealer

Replace fuel

Clean or replace air filter

Reduce load

Used specified fuel

Clean or replace air filter

Reduce to specified level

Consult your authorized dealer

Lower speed or reduce load

Replenish engine oil

Mud acts as an insulator. Clean engine

Remove all trash and mud

Consult your authorized dealer

Adjust the spark plug gap or replace it

Allow time for engine to warm before driving

Consult your authorized dealer

Consult your authorized dealer

Adjust cable

Clean or replace

Countermeasure

Use **low range** only

Shift the transmission to **low range** and carefully use fast throttle application to engage clutch.

DANGER: Excessive throttle may cause loss of control and vehicle overturn.

Allow belt to cool.

Warm the engine at least 5 minutes. With the transmission in neutral, advance the throttle to about 1/8 throttle in short bursts, 5 times

Allow the engine to run for a few minutes



BATTERY TROUBLESHOOTING

Trouble	Cause	
Starter does not function	Battery overused until lights are dim	
	Battery has not been recharged	
	Poor terminal connection	
	Battery life expired	
From beginning starter does not function, and lights soon become dim	Insufficient charging	
When viewed from top, the top of plates or terminals look whitish	Battery was used with an insufficient amount of electrolyte	
	Battery was used too much without recharging	
Recharging is impossible	Battery life expired	
Terminals are severely corroded and heat up	Poor terminal connection	
Battery electrolyte	There is a crack or pin holes in the electrolytic cells	
	Charging system trouble	

Countermeasure	Preventive Measure
Charge battery sufficiently	Charge battery properly
Clean the terminal and tighten securely	Keep the terminal clean and tight. Apply grease and treat with anti-corrosives
Renew battery	
Charge battery sufficiently	Battery must be serviced properly before initial use
Add distilled water and charge battery	Regularly check the electrolyte level
Charge battery sufficiently	Charge the battery properly
Replace battery	
Clean the terminal and tighten securely	Keep the terminal clean and tight. Apply grease and treat with anti-corrosives
Replace battery	
Consult your authorized dealer	



LIMITED WARRANTY:

LIMITED 3-YEAR ENGINE WARRANTY

Kohler Co. warrants to the original retail consumer that each new KOHLER Diesel engine sold by Kohler Co. will be free from manufacturing defects in materials or workmanship in normal service for a period of three (3) years or 2000 hours whichever occurs first from the date of purchase, provided it is operated and maintained in accordance with Kohler Co.'s instructions and manuals. If no hour meter is installed as original equipment then 8 hours of use per day and 5 days per week will be used to calculate hours used. Please consult Kohler Owner's Manual for instructions and exclusions to this manufacturer's warranty. Intimidator, Inc. does not assume any warranty obligation, liability, or modification for this item.

3-YEAR LIMITED DRIVETRAIN WARRANTY

Intimidator, Inc. will, at its option, repair or replace, without charge, the drivetrain including gearbox, Constant Velocity Transmission (CVT) clutches excluding belt, transaxles excluding CV Joints, driveshaft's and their subcomponents and differentials if found to be defective in material and/or workmanship within three (3) years after date of sale to the original retail purchaser of a new Intimidator 4x4 diesel model. This limited warranty is non-transferable to a 2nd party and will be subject to certain limitations.

1-YEAR LIMITED BUMPER-TO-BUMPER WARRANTY

Intimidator, Inc. will, at its option, repair or replace, without charge, any part covered by the warranty which is found to be defective in material and/or workmanship within 1 year after date of sale to the original retail purchaser of a new Intimidator 4x4 diesel model. This limited warranty is non-transferable to a 2nd party and will be subject to certain limitations.

REPLACEMENT PARTS

Intimidator, Inc. dealers will repair or replace, at Intimidator, Inc.'s option, any defective part during the one (1) year warranty period. The parts to be warranted must be defective in material and/or workmanship. All replacement parts must be obtained from Intimidator 4x4 in order to comply with this manufacturer's warranty.

BATTERY WARRANTY

The batteries used to power the Intimidator 4x4 will carry a 6-month free replacement warranty. These warranty claims will be handled by the battery manufacturer, Interstate Battery. Intimidator 4x4 does not assume any warranty obligation, liability, or modification for this item.

DIESEL

WARRANTY LIMITATIONS AND EXCLUSIONS

This warranty excludes any failures that are not caused by a defect in material or workmanship. This warranty does not cover defects caused by normal wear, accidents, improper maintenance, improper use or abuse of the product, or failure to follow the instructions contained in any owner's manual for operation and maintenance. This warranty also does not cover any vehicle that has been altered structurally, modified, neglected, improperly maintained, or used for purposes other than what the vehicle was designed for. Also, this warranty does not cover physical damage to paint or finish, tearing or puncturing of upholstery material, fading of seats due to exposure, stains on interior, corrosion, or defects in parts components or the vehicle due to fire, explosions or any other cause beyond Intimidator, Inc.'s control. This warranty also excludes failures resulting from improper lubrications; improper fuel; surface imperfections of fading caused by external stress, harmful cleaning solvents or fading; repairs made by an unauthorized repair center. Warranty does not apply to "wearable" items or items considered being part of normal maintenance. "Wearable" items and normal maintenance components include but are not limited to; spark plugs, wheels and tires, filters, fuel, sealants, lubricants, cosmetic damage, CVT belt, circuit relays/fuses, brake components and coolants. Warranty does not cover personal loss items such as towing charges, mileage, rentals loss, pick-up and delivery fees, or loss of vacation/personal time. The customer must operate and maintain his/her machine within the proper guidelines of the Owner's Manual.

RESPONSIBILITY OF THE CUSTOMER

It is the responsibility of the customer to register his/her Intimidator, Inc. for warranty by promptly returning a completed warranty registration card within thirty (30) days from the date of purchase.

This warranty gives you specific legal rights, and you may also have other rights which may vary from state to state.

Any warranty issues or questions can be handled by your Intimidator, Inc. dealer or at: Intimidator Inc., 1 Bad Boy Blvd, Batesville, AR 72501. (855) 307-0933



LIMITED WARRANTY

LIMITED 3-YEAR ENGINE WARRANTY

Kohler Co. warrants to the original retail consumer that each new KOHLER Gasoline engine sold by Kohler Co. will be free from manufacturing defects in materials or workmanship in normal service for a period of three (3) years from the date of purchase provided it is operated and maintained in accordance with Kohler Co.'s instructions and manuals. Please consult Kohler Owner's Manual for instructions and exclusions to this manufacturer's warranty. Intimidator, Inc. does not assume any warranty obligation, liability, or modification for this item.

3-YEAR LIMITED DRIVETRAIN WARRANTY

Intimidator, Inc. will, at its option, repair or replace, without charge, the drivetrain including gearbox, Constant Velocity Transmission (CVT) clutches excluding belt, transaxles excluding CV Joints, driveshaft's and their subcomponents and differentials if found to be defective in material and/or workmanship within three (3) years after date of sale to the original retail purchaser of a new Intimidator 4x4 diesel model. This limited warranty is non-transferable to a 2nd party and will be subject to certain limitations.

1-YEAR LIMITED WARRANTY

Intimidator, Inc. will, at its option, repair or replace, without charge, any part covered by the warranty which is found to be defective in material and/or workmanship within one (1) year after date of sale to the original retail purchaser of a new Intimidator, Inc. gasoline model. This limited warranty is non-transferable to a 2nd party and will be subject to certain limitations.

REPLACEMENT PARTS

Intimidator, Inc. dealers will repair or replace, at Intimidator, Inc.'s option, any defective part during the one (1) year warranty period. The parts to be warranted must be defective in material and/or workmanship. All replacement parts must be obtained from Intimidator, Inc. in order to comply with this manufacturer's warranty.

BATTERY WARRANTY

The batteries used to power the Intimidator, Inc. will carry a 6-month free replacement warranty. These warranty claims will be handled by the battery manufacturer, Interstate Battery. Intimidator, Inc. does not assume any warranty obligation, liability, or modification for this item.

750 CC GAS

WARRANTY LIMITATIONS AND EXCLUSIONS

This warranty excludes any failures that are not caused by a defect in material or workmanship. This warranty does not cover defects caused by normal wear, accidents, improper maintenance, improper use or abuse of the product, or failure to follow the instructions contained in any owner's manual for operation and maintenance. This warranty also does not cover any vehicle that has been altered structurally, modified, neglected, improperly maintained, or used for purposes other than what the vehicle was designed for. Also, this warranty does not cover physical damage to paint or finish, tearing or puncturing of upholstery material, corrosion, or defects in parts components or the vehicle due to fire, explosions or any other cause beyond Intimidator Inc.'s control. This warranty also excludes failures resulting from; improper lubrications, improper fuel, surface imperfections of fading caused by external stress, harmful cleaning solvents or fading; repairs made by an unauthorized repair center. Warranty does not apply to "wearable" items or items considered being part of normal maintenance. "Wearable" items and normal maintenance components include but are not limited to; spark plugs, filters, fuel, sealants, lubricants, cosmetic damage, CVT belt, circuit relays/fuses, brake components and coolants. Warranty does not cover personal loss items such as towing charges, mileage, rentals loss, pick-up and delivery fees, or loss of vacation/personal time. The customer must operate and maintain his/her machine within the proper guidelines of the Owner's Manual.

RESPONSIBILITY OF THE CUSTOMER

It is the responsibility of the customer to register his/her Intimidator 4x4 for warranty by promptly returning a completed warranty registration card within thirty (30) days from the date of purchase.

This warranty gives you specific legal rights, and you may also have other rights which may vary from state to state.

Any warranty issues or questions can be handled by your Intimidator, Inc. dealer or at: **Intimidator 4x4, 1 Bad Boy Blvd., Batesville, AR 72501. (855) 307-0933**



LIMITED WARRANTY

LIMITED 1-YEAR ENGINE WARRANTY

Intimidator, Inc. warrants to the original retail consumer that each new Intimidator Motors Gasoline engine sold by Intimidator, Inc., will be free from manufacturing defects in materials or workmanship in normal service for a period of one (1) year from the date of purchase provided it is operated and maintained in accordance with Intimidator, Inc.'s instructions and manuals. Please consult the Intimidator Owner's Manual for instructions and exclusions to this manufacturer's warranty.

1-YEAR LIMITED DRIVETRAIN WARRANTY

Intimidator, Inc. will, at its option, repair or replace, without charge, the drivetrain including gearbox, Constant Velocity Transmission (CVT) clutches excluding belt, transaxles excluding CV Joints, driveshaft's and their subcomponents and differentials if found to be defective in material and/or workmanship within one (1) year after date of sale to the original retail purchaser of a new Intimidator 4x4 800cc gasoline model. This limited warranty is non-transferable to a 2nd party and will be subject to certain limitations.

1-YEAR LIMITED BUMPER-TO-BUMPER WARRANTY

Intimidator, Inc. will, at its option, repair or replace, without charge, any part covered by the warranty which is found to be defective in material and/or workmanship within one (1) year after date of sale to the original retail purchaser of a new Intimidator, Inc. gasoline model. This limited warranty is non-transferable to a 2nd party and will be subject to certain limitations.

REPLACEMENT PARTS

Intimidator, Inc. dealers will repair or replace, at Intimidator, Inc.'s option, any defective part during the one (1) year warranty period. The parts to be warranted must be defective in material and/or workmanship. All replacement parts must be obtained from Intimidator, Inc. in order to comply with this manufacturer's warranty.

BATTERY WARRANTY

The batteries used to power the Intimidator, Inc. will carry a 6-month free replacement warranty. These warranty claims will be handled by the battery manufacturer, Interstate Battery. Intimidator, Inc. does not assume any warranty obligation, liability, or modification for this item.

800 CC GAS

WARRANTY LIMITATIONS AND EXCLUSIONS

This warranty excludes any failures that are not caused by a defect in material or workmanship. This warranty does not cover defects caused by normal wear, accidents, improper maintenance, improper use or abuse of the product, or failure to follow the instructions contained in any owner's manual for operation and maintenance. This warranty also does not cover any vehicle that has been altered structurally, modified, neglected, improperly maintained, or used for purposes other than what the vehicle was designed for. Also, this warranty does not cover physical damage to paint or finish, tearing or puncturing of upholstery material, corrosion, or defects in parts components or the vehicle due to fire, explosions or any other cause beyond Intimidator, Inc.'s control. This warranty also excludes failures resulting from; improper lubrications, improper fuel, surface imperfections of fading caused by external stress, harmful cleaning solvents or fading; repairs made by an unauthorized repair center. Warranty does not apply to "wearable" items or items considered being part of normal maintenance. "Wearable" items and normal maintenance components include but are not limited to; spark plugs, filters, fuel, sealants, lubricants, cosmetic damage, CVT belt, circuit relays/fuses, brake components and coolants. Warranty does not cover personal loss items such as towing charges, mileage, rentals loss, pick-up and delivery fees, or loss of vacation/personal time. The customer must operate and maintain his/her machine within the proper guidelines of the Owner's Manual.

RESPONSIBILITY OF THE CUSTOMER

It is the responsibility of the customer to register his/her Intimidator 4x4 for warranty by promptly returning a completed warranty registration card within thirty (30) days from the date of purchase.

This warranty gives you specific legal rights, and you may also have other rights which may vary from state to state.

Any warranty issues or questions can be handled by your Intimidator, Inc. dealer or at: **Intimidator 4x4, 1 Bad Boy Blvd., Batesville, AR 72501. (855) 307-0933**



EMISSIONS WARRANTY

EMISSION SYSTEM WARRANTY STATEMENT (UTV)

DISTRIBUTOR'S LIMITED WARRANTIES EMISSION CONTROL SYSTEMS

Intimidator must warrant the emission control system on your 2016 and subsequent model year UTV for the period of time listed on the following page, provided there has been no abuse, neglect, or improper maintenance of your UTV.

Your emission control system may include parts such as the carburetor or fuel injection system, the ignition system, and engine computer. Also included may be hoses, belts, connectors, and other emission-related assemblies. Where a warranted condition exists, Intimidator will repair your UTV at no cost to you, including diagnosis, parts, and labor.

Intimidator UTVs comply with U.S. EPA emissions regulations. Intimidator provides the same warranty coverage to all motorcycle owners, regardless of where the UTV is registered.

YOUR WARRANTY RIGHTS AND OBLIGATIONS

In the United States new UTV's must be designed, built and equipped to meet stringent federal anti-smog standards. Intimidator must warrant the emissions control system on your UTV for the periods of time listed below, provided there has been no abuse, neglect or improper maintenance of your UTV. Your emissions control system may include parts such as the sensors, the ignition and the engine computer. Also included may be hoses, connectors and other emissions-related assemblies. Where a warrantable condition exists, Intimidator will repair your UTV at no cost to you, including diagnosis, parts, and labor.

MANUFACTURER'S WARRANTY COVERAGE

If any emissions-related part on your UTV is defective, the part will be repaired or replaced by Intimidator. This is your emissions control system DEFECTS WARRANTY.

OWNER'S WARRANTY RESPONSIBILITIES

As the UTV owner, you are responsible for the performance of the required maintenance listed in your Owner's Manual. Intimidator, Inc. recommends that you retain all receipts covering maintenance on your UTV, but Intimidator cannot deny warranty solely for the lack of receipts or for your failure to ensure the performance of all scheduled maintenance. You are responsible for presenting your UTV to an Intimidator dealer as soon as a problem exists. The warranty repairs should be completed in a reasonable amount of time, not to exceed thirty (30) days.

EMISSION SYSTEM WARRANTY STATEMENT (UTV)

As the UTV owner, you should also be aware that Intimidator may deny you warranty coverage if your UTV or a part has failed due to abuse, neglect, improper maintenance or unapproved modifications. If you have any questions regarding your warranty rights and responsibilities or if an authorized Intimidator dealer cannot repair your UTV or honor your claim within a reasonable period of time, contact Intimidator @ (866) 622-3269 for assistance. If you are not satisfied with the way in which a warranty claim is resolved by Intimidator, you may write directly to:

Director of Field Operations / Support Division (E14-397F)
Environmental Protection Agency
Washington, D.C. 20460



EMISSIONS WARRANTY

EMISSIONS WARRANTY COVERAGE

Intimidator warrants to the owner of any 2016 and subsequent model year UTV that the unit is designed, built and equipped to conform at the time of sale with all applicable emission standards, and is free from defects in materials and workmanship which would cause it to fail to conform with applicable requirements during the specified time and mileage limits.

This warranty begins on the date the UTV is delivered to the first purchaser other than an authorized Intimidator motorcycle dealer, or the date it is first used as a demonstrator, lease, or company UTV, whichever comes first and continues for the time and mileage listed below:

Time: 30 Months; or

Mileage: 3,100 Miles (5,000 kilometer) – Whichever comes first. These warranties are given only to the owner of a 2016 and subsequent model year UTV distributed by Intimidator.

EMISSION SYSTEM WARRANTY STATEMENT (UTV)

To qualify for coverage under the defects warranty you should operate and maintain your UTV according to the requirements of the Warranty Booklet, and the Maintenance Schedule in the Owner's Manual. This schedule is designed to keep your UTV emission control systems functioning properly by maintaining your UTV in peak operating condition. Intimidator will not deny a warranty claim solely because of lack of maintenance records. However, failures caused by abuse or lack of required maintenance will not be covered by this warranty.

Intimidator recommends that only parts supplied by Intimidator or equivalent parts be used to repair your UTV. Maintenance, replacement, or repair of emission control devices and systems may be done by any UTV repair establishment or individual. Intimidator will only pay for warranty repairs performed at an authorized Intimidator UTV repair facility (except in an emergency situation). An emergency situation exists when an Intimidator dealership is not reasonably available, a warranted part is not available within thirty (30) days, or when an authorized Intimidator facility is unable to complete a repair within thirty (30) days. In an emergency situation, the repair of emission control devices or system may be done by any UTV repair establishment or individual, or by the owner, using any replacement part. Intimidator will reimburse you for those emergency repairs, including diagnosis, covered by the Emissions Warranties. Parts reimbursement is at the manufacturer's suggested retail price, and labor reimbursement is at a geographically-appropriate hourly labor rate for Intimidator recommended time allowance. For reimbursement, present the replaced parts and a copy of the paid receipt to Intimidator.

The use of replacement parts not equivalent to the original parts may impair the effectiveness of your UTV emissions control systems. If such a replacement part is used in the maintenance or repair of your UTV, and an authorized Intimidator dealer determines it is defective or caused a failure of a warranted part, your claim for repair to bring your UTV into compliance with applicable standards may be denied. If the part in question is not related to the reason your UTV fails to meet the standards, your claim will not be denied.



SERVICE RECORD

PDI

Date: _____

Hour Meter Reading: _____

Dealer Stamp: _____

1st Service

Date: _____

Hour Meter Reading: _____

Dealer Stamp: _____

2nd Service

Date: _____

Hour Meter Reading: _____

Dealer Stamp: _____

3rd Service

Date: _____

Hour Meter Reading: _____

Dealer Stamp: _____

4th Service

Date: _____

Hour Meter Reading: _____

Dealer Stamp: _____

5th Service

Date: _____

Hour Meter Reading: _____

Dealer Stamp: _____

6th Service

Date: _____

Hour Meter Reading: _____

Dealer Stamp: _____

7th Service

Date: _____

Hour Meter Reading: _____

Dealer Stamp: _____

8th Service

Date: _____

Hour Meter Reading: _____

Dealer Stamp: _____



INTIMIDATOR, INC. UTILITY VEHICLE OWNER'S REGISTRATION & TRAINING CERTIFICATE

(Keep original copy on file at your dealership)

VIN/PIN _____

MODEL _____

DATE OF PURCHASE _____

DEALER _____

PURCHASER

LAST NAME _____

FIRST NAME _____

ADDRESS _____

CITY _____

STATE _____

POSTAL CODE _____

DAY PHONE _____

EVENING PHONE _____

Safety Check List

Purchaser: By initialing each line, I understand and give my word of Honor

_____ This Utility Vehicle must not be operated by anyone under the age indicated in the Operator's Manual. I will not allow anyone under the age indicated in the Operator's Manual to operate this vehicle. Every operator must read and understand the Operator's manual before riding this Utility Vehicle.

_____ This Utility Vehicle must not be operated by anyone who does not have a valid driver's license.

_____ Never ride a Utility Vehicle after consuming alcohol or drugs.

_____ Overly aggressive use on inclines may cause the Utility Vehicle to flip over.

_____ Always ride within your abilities.

_____ Never attempt jumps or other stunts.

_____ Always be extra careful when riding on unfamiliar terrain, steep slopes, or when encountering obstacles.

_____ I have read the above warnings, and I understand that SEVERE INJURY OR DEATH can result from ignoring these warnings or from improper use.

_____ I will watch the safety/training video provided by Intimidator, Inc., before operating this vehicle.

Purchaser's Signature

Date

I have reviewed the safety features and Operator's Manual with this purchaser and to all appropriate immediate family members prior to their taking delivery of this UTV and qualifying them for warranty. The UTV described above has been serviced and approved for delivery by me or an employee on my behalf. I will maintain this Owner Registration Form from the customer and me in a paper form along with other books and records of the dealership.

Authorized Dealership Signature

Date



OWNER'S MANUAL

1000cc Kohler Diesel •

Intimidator 800 • 750 EFI Kohler Gas

Please call an authorized Intimidator dealer for Parts, Service and Warranty. For a dealer locator and additional information, please see us at:

www.intimidatorUTV.com

Intimidator, Inc.

1 Bad Boy Blvd.

Batesville, Arkansas 72501

(855) 307-0933